

Periodontal / Parodontologia

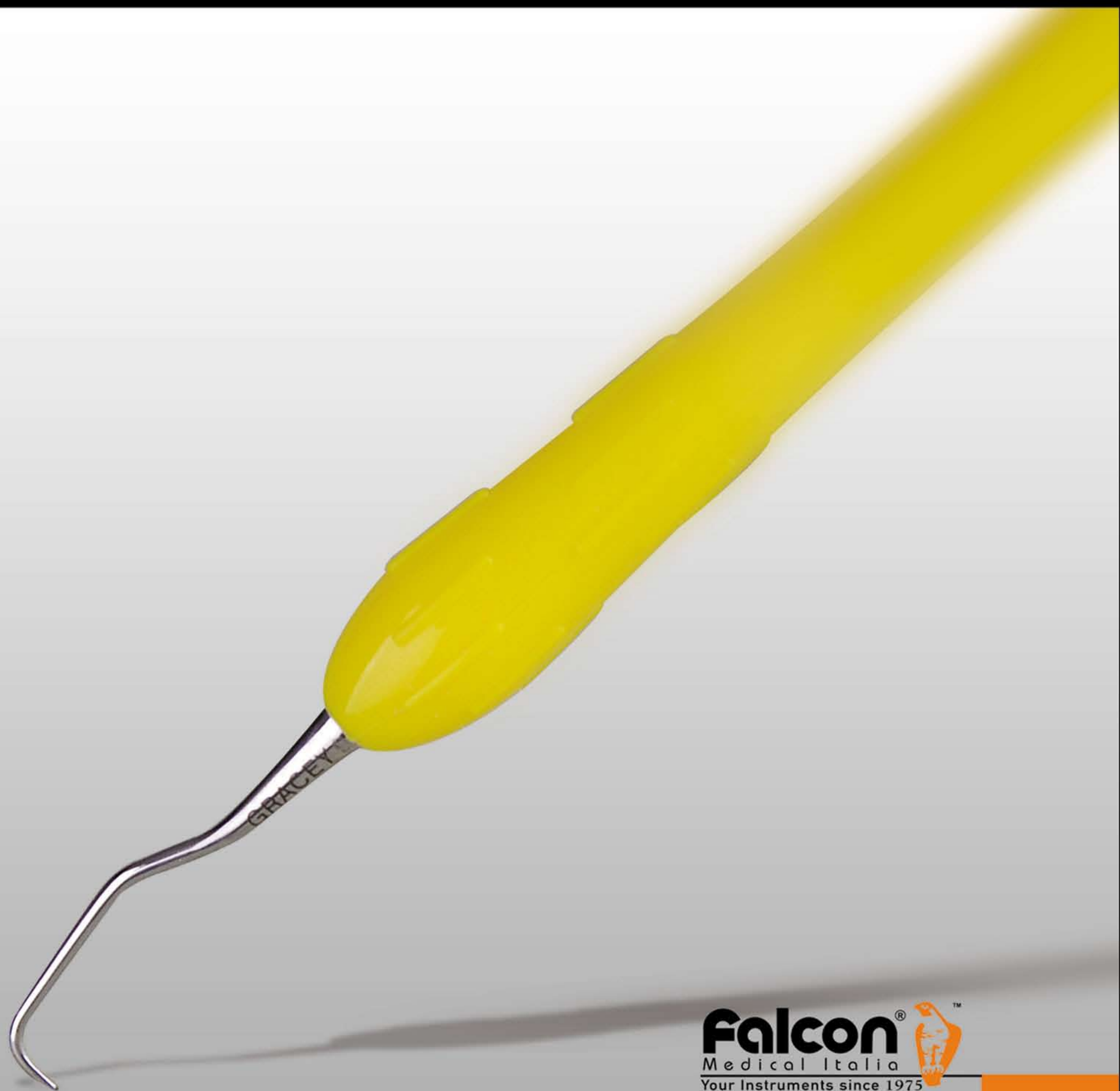

Ultrasonic Tips / Punta per Ultrasuoni

Ultrasonic scaling tips / Punta per ablazione



Type / Tipo E

Type / Tipo S



G1

DP.005.010

DP.006.010



G2

DP.005.020

DP.006.020



G3

DP.005.030

DP.006.030



G4

DP.005.040

DP.006.040



G5

DP.005.050

DP.006.050



G6

DP.005.060

DP.006.060

Ultrasonic periodontal tips / Punta per parodontologia



Type / Tipo E

Type / Tipo S



P3D

DP.009.030

DP.010.030



Diamond Coated
Punta Diamantate



P4D

DP.009.040

DP.010.040



P1

DP.007.010

DP.008.010



P3

DP.007.030

DP.008.030



P4

DP.007.040

DP.008.040

Accessories / Accessori



Autoclavabile
Autoclavabile



Torque wrench / Chiave tubolare
DP.004.010



Tips holder / Porta punta
DP.004.020



Tightening key / Chiave di serraggio
DP.005.000



Quick connector / Attacco rapido
DP.004.030



Gracey Currettes

Curette di Gracey

- Ergonomic, large diameter silicone handle for better grip
- Ultra light weight
- Special grade stainless steel tips ensure longer life
- Rigid pattern, thicker tips than standard Gracey
- Manico ergonomic di grosso diam., in silicone, per maggior grip
- Ultraleggero
- Uso di speciale a. inox assicura elevata longevità
- Punta rigide piu' robuste delle Gracey standard

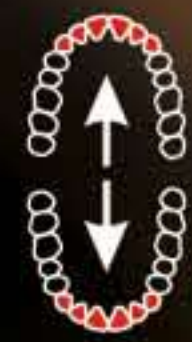

Anterior teeth
Denti anteriori



Fig. 1/2
DP.156.021 rigid
DP.160.021 standard
Grey / Grigio

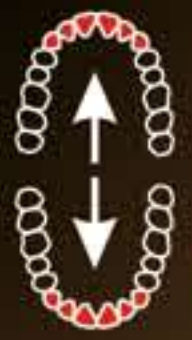

Anterior teeth
Denti anteriori



Fig. 3/4
DP.156.041 rigid
DP.160.041 standard
Black / Nero

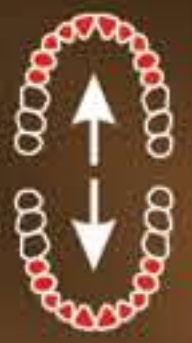

Anterior and Premolars
Denti anteriori e Premolari



Fig. 5/6
DP.156.061 rigid
DP.160.061 standard
Yellow / Giallo



Premolars and Molars
Denti Premolari e Molari



Fig. 7/8
DP.156.081 rigid
DP.160.081 standard
Green / Verde

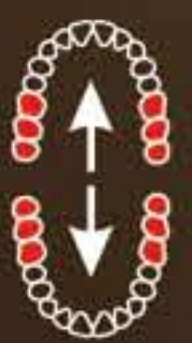

Molars buccal and lingual surfaces
Molari, superfici buccali e linguali



Fig. 9/10
DP.156.101 rigid
DP.160.101 standard
Red / Rosso



Posterior mesial surfaces
Superfici mesiali posteriori



Fig. 11/12
DP.156.111 rigid
DP.160.111 standard
Orange / Arancione

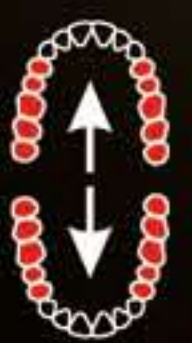

Posterior distal surfaces
Superfici distali posteriori



Fig. 13/14
DP.156.141 rigid
DP.160.141 standard
Blue / Blu



DP.156.000 rigid
Set of 7 pieces / Serie da 7 pezzi



DP.999.011 standard
Set of 7 pieces / Serie da 7 pezzi

Gracey Curettes Curette di Gracey

SOFT LINE INSTRUMENTS
soft and sure grip

135° C
Autoclavabile
Autoclavabile

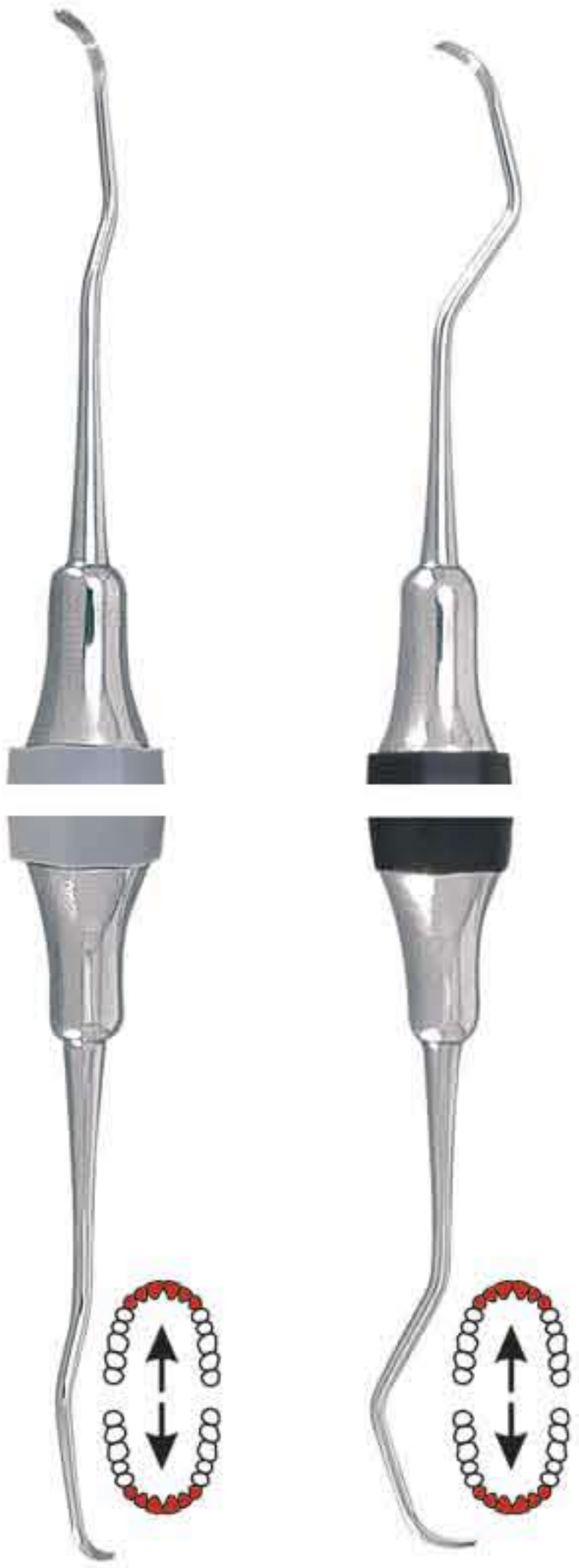

Fig. 1/2
DP.160.024
Grey / Grigio

Anterior teeth
Denti anteriori

Fig. 3/4
DP.160.044
Black / Nero

Anterior teeth
Denti anteriori



Fig. 5/6
DP.160.064
Yellow / Giallo

Anterior and Premolars
Denti anteriori e Premolari



Fig. 7/8
DP.160.084
Green / Verde

Premolars and Molars
Denti Premolari e Molari



Fig. 9/10
DP.160.104
Red / Rosso

Molars buccal and lingual surfaces
Molari, superfici boccali e linguali



Fig. 11/12
DP.160.114
Orange / Arancione

Posterior mesial surfaces
Superfici mesiali posteriori



Fig. 13/14
DP.160.144
Blue / Blu

Posterior distal surfaces
Superfici distali posteriori

Periodontal



Fig. 15/16
DP.160.164
Coffee / Caffè

Posterior mesial surfaces
Superfici mesiali posteriori

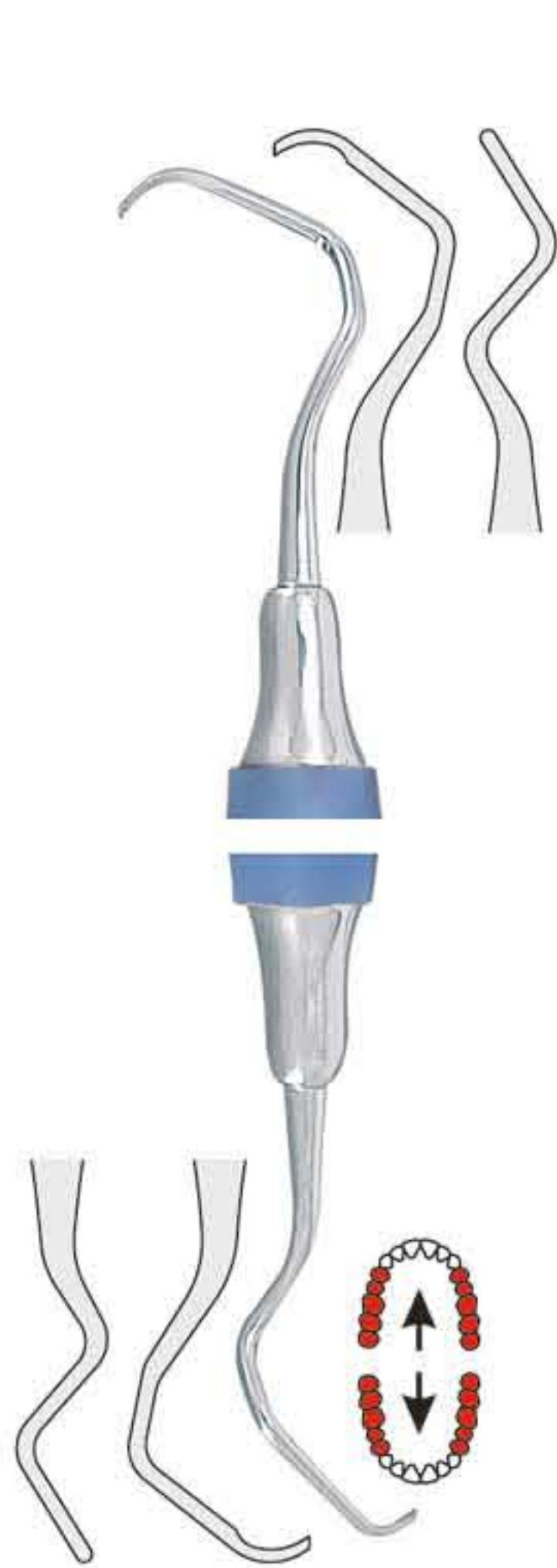

Fig. 17/18
DP.160.184
Light Blue / Celeste

Posterior distal surfaces
Superfici distali posteriori



Fig. 11/14
DP.160.124
Orange-Blue / Arancione-Blu

Mesial/Distal surfaces
Superfici mesiali/distali



Fig. 12/13
DP.160.134
Orange-Blue / Arancione-Blu

Mesial/Distal surfaces
Superfici mesiali/distali



DP.999.014
Set of 7 pieces / Serie da 7 pezzi
Contents / Contenuto
Fig. 1/2, 3/4, 5/6, 7/8, 9/10, 11/12, 13/14



Classic-Round 6 mm solid handle
Manico pieno da 6mm



CLASSIC-LITE 8 mm hollow handle
Manico vuoto da 8 mm

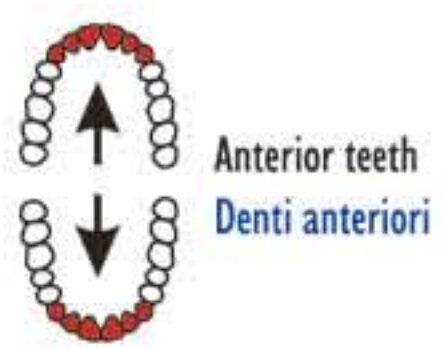

Anterior teeth
Denti anteriori

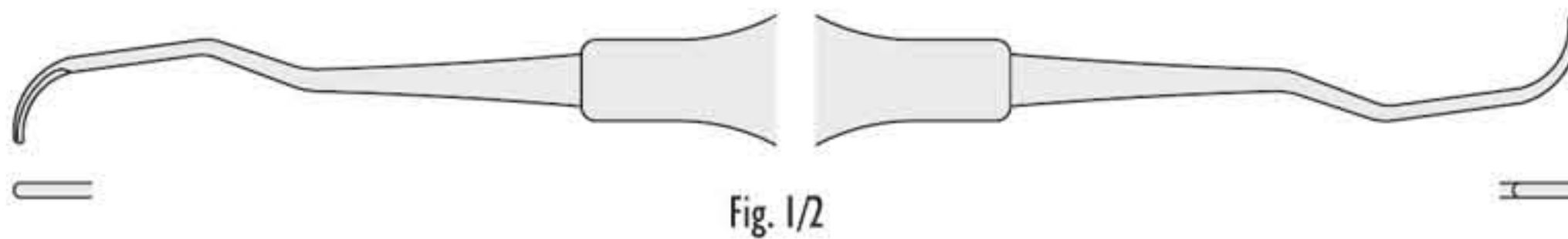
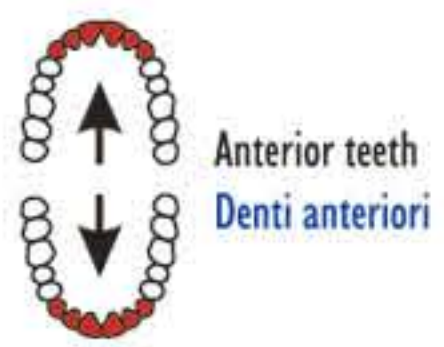

Fig. 1/2



Anterior teeth
Denti anteriori

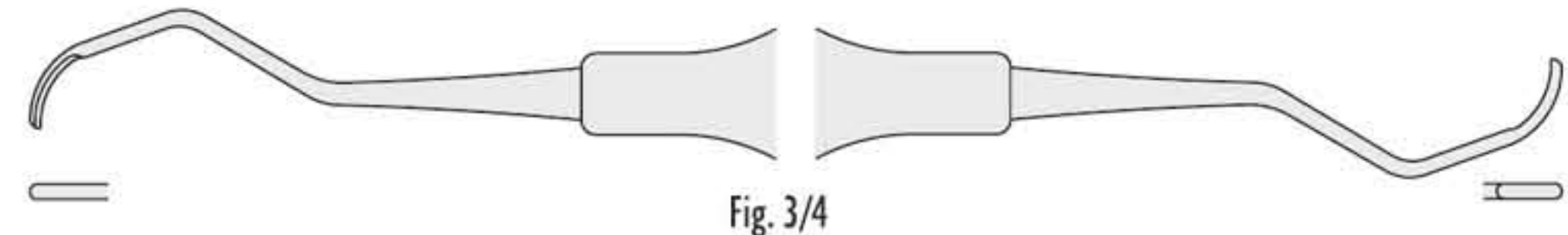

Fig. 3/4



Anterior and
Premolars
Denti anteriori
e Premolari

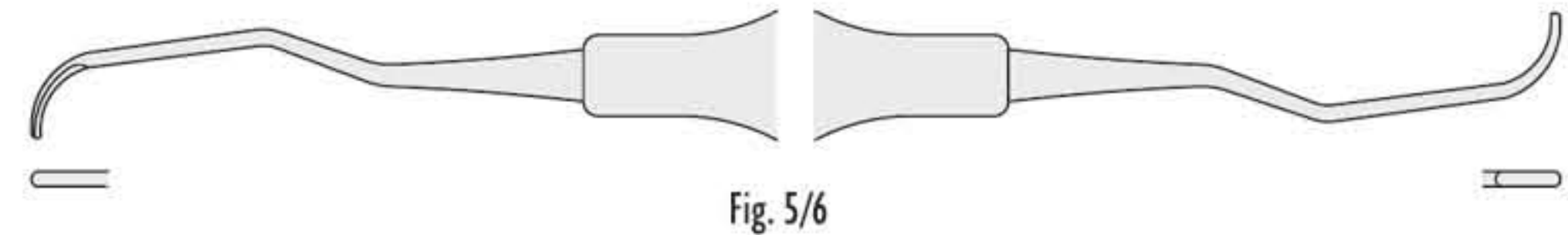
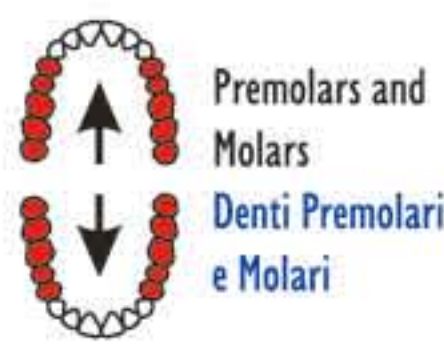

Fig. 5/6



Premolars and
Molars
Denti Premolari
e Molari

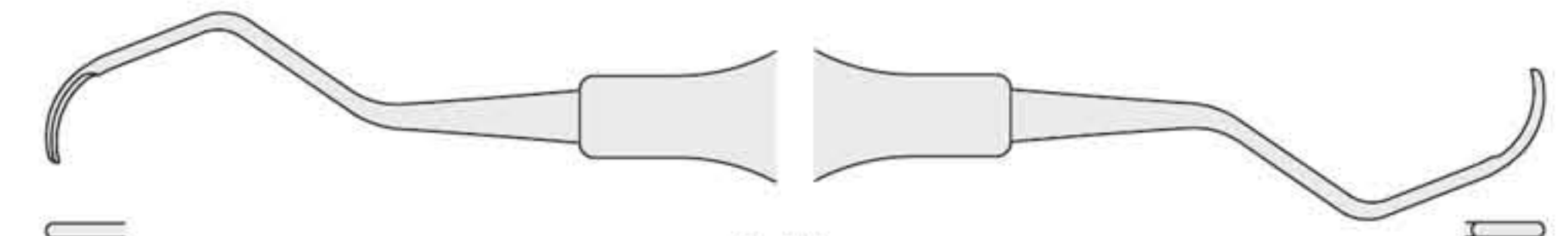
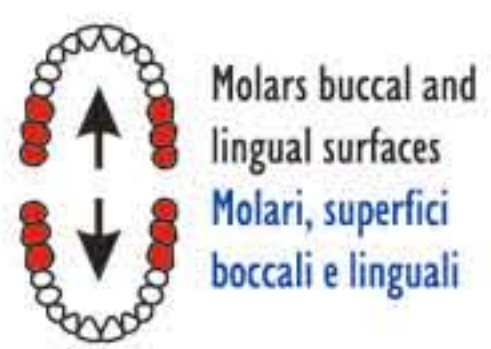

Fig. 7/8



Molars buccal and
lingual surfaces
Molari, superfici
boccali e linguali

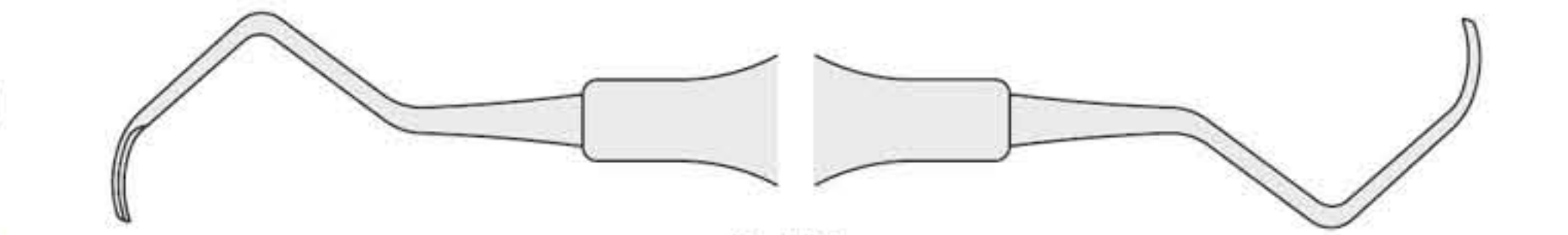
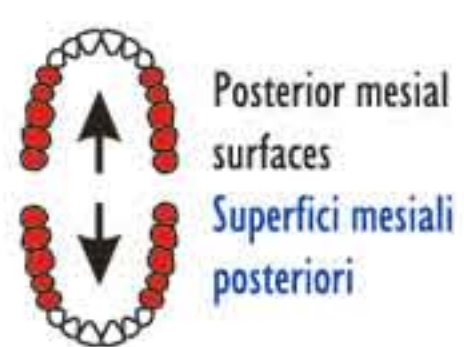

Fig. 9/10



Posterior mesial
surfaces
Superfici mesiali
posteriori

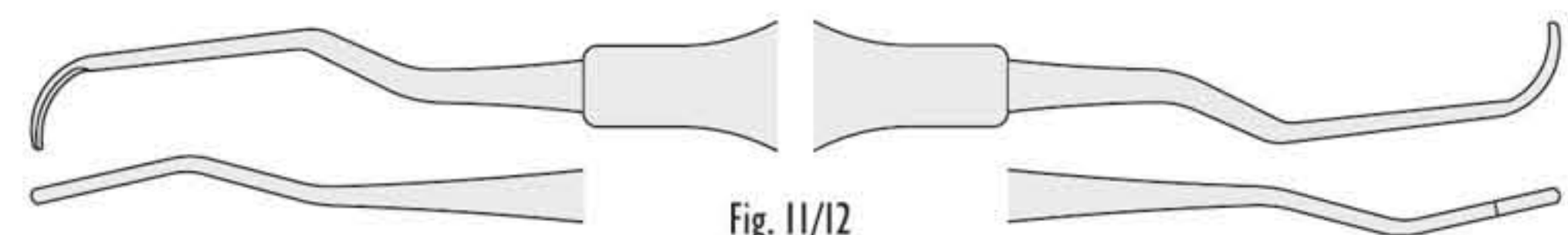
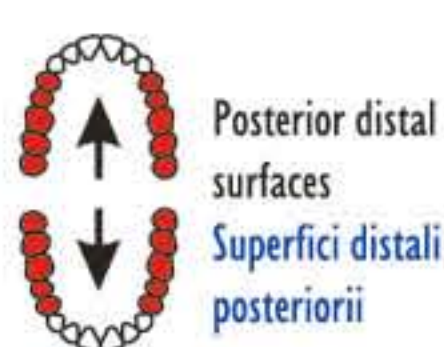

Fig. 11/12



Posterior distal
surfaces
Superfici distali
posteriori

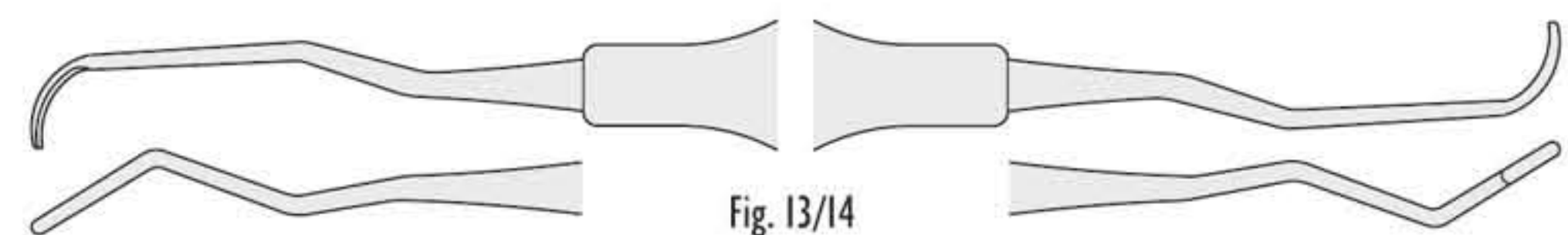

Fig. 13/14

	Classic-Round	CLASSIC-LITE
Fig. 1/2	DP.160.020	DP.160.025
Fig. 3/4	DP.160.040	DP.160.045
Fig. 5/6	DP.160.060	DP.160.065
Fig. 7/8	DP.160.080	DP.160.085
Fig. 9/10	DP.160.100	DP.160.105
Fig. 11/12	DP.160.110	DP.160.115
Fig. 13/14	DP.160.140	DP.160.145



DP.999.015
Gracey set of 7 pieces
Gracey serie da 7 pezzi



DP.999.020
Gracey set of 7 pieces
Gracey serie da 7 pezzi



Periodontal chisels / Scalpelli per parodontologia



Fig. 1 DP.085.013 TG

Fig. 2 DP.085.023 TG

Universal curettes / Curettes universali



Classic-Round 6 mm solid handle
Manico pieno da 6 mm

CLASSIC-LITE 8 mm hollow handle
Manico vuoto da 8 mm

Columbia

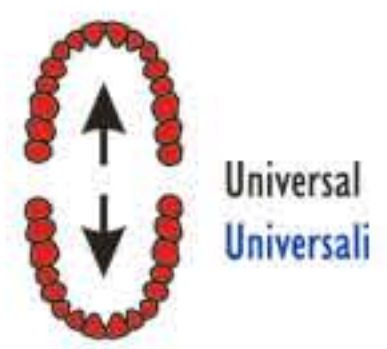
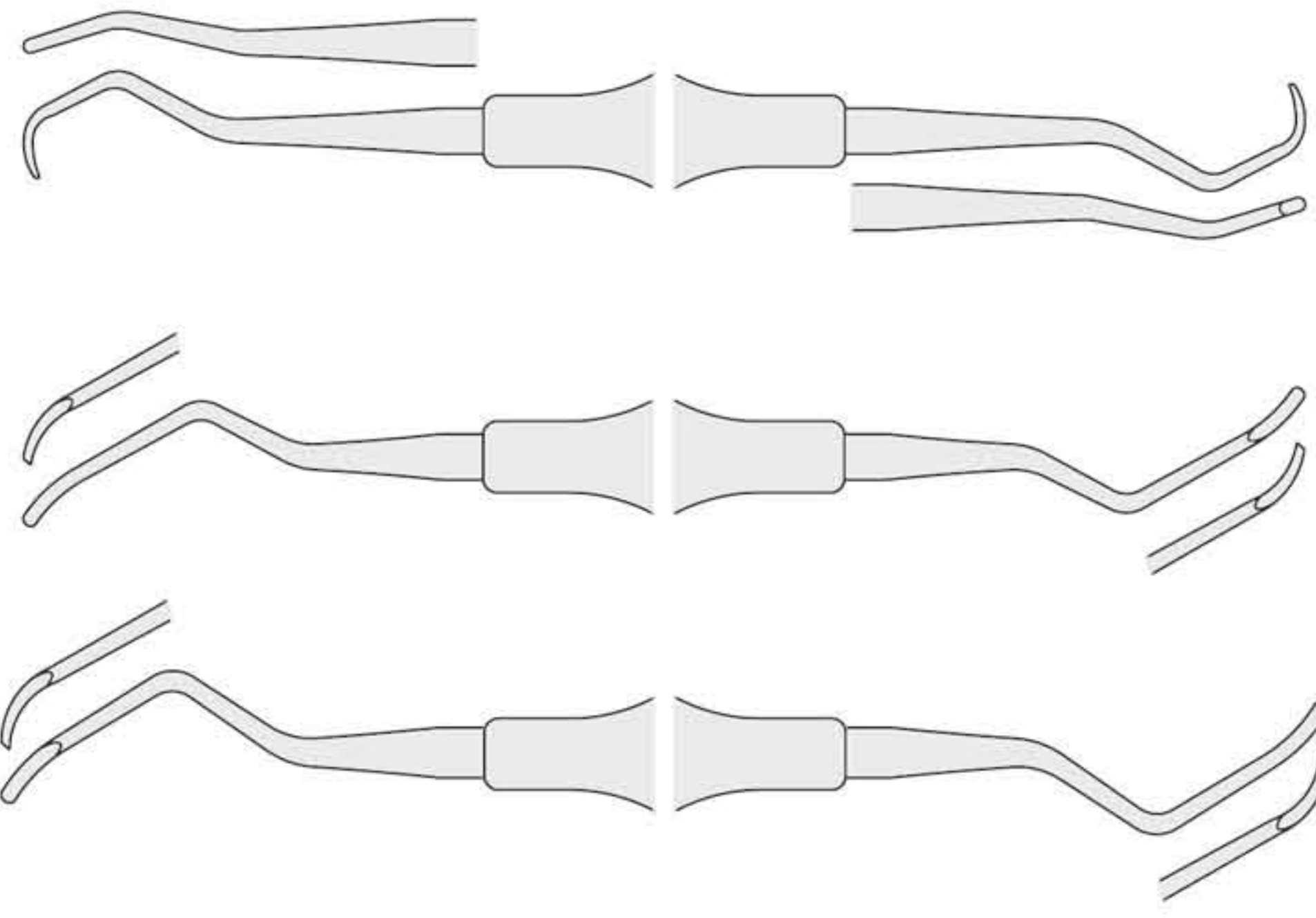

Universal
Universali



Anterior teeth
Denti anteriori

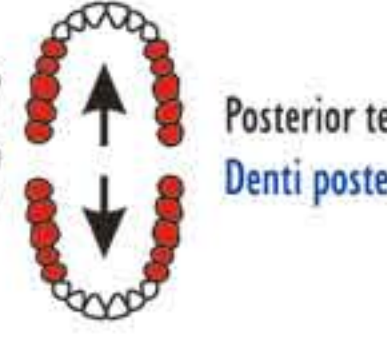

Posterior teeth
Denti posteriori

	Classic-Round	CLASSIC-LITE
Fig. 13/14	DP.125.140	DP.125.145
Fig. 2R/2L	DP.128.020	DP.128.025
Fig. 4R/4L	DP.128.040	DP.128.045

Hoe scalers / Curette sopra-gengivali a "zappa"



Classic-Round 6 mm solid handle
Manico pieno da 6 mm

CLASSIC-LITE 8 mm hollow handle
Manico vuoto da 8 mm

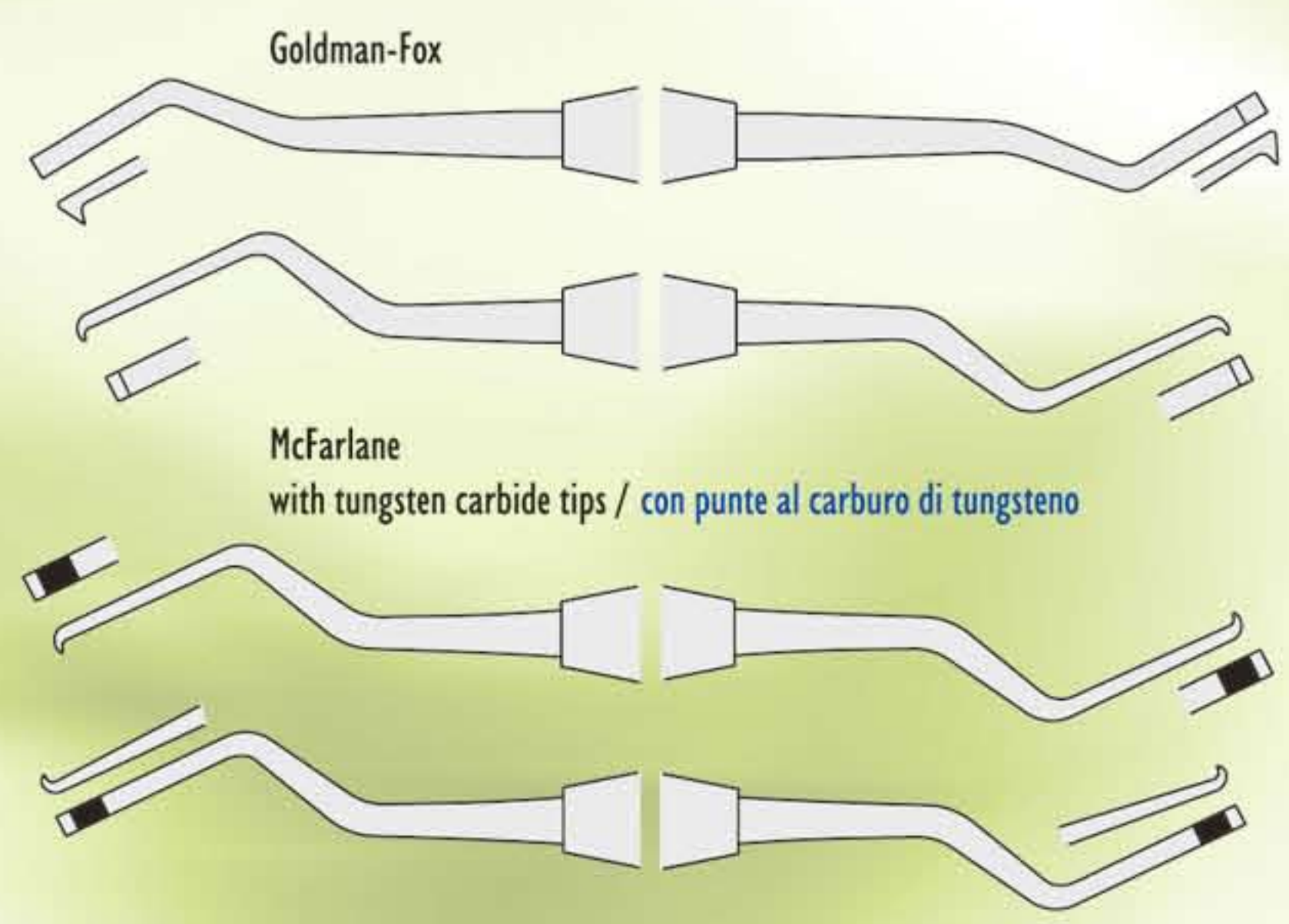

Goldman-Fox

McFarlane
with tungsten carbide tips / con punte al carburo di tungsteno

	Classic-Round	CLASSIC-LITE
Fig. 5	DP.365.050	DP.365.055
Fig. 6	DP.365.060	DP.365.065
Fig. 6/7	-----	DP.375.075
Fig. 8/9	-----	DP.375.095



SOFT LINE INSTRUMENTS
soft and sure grip

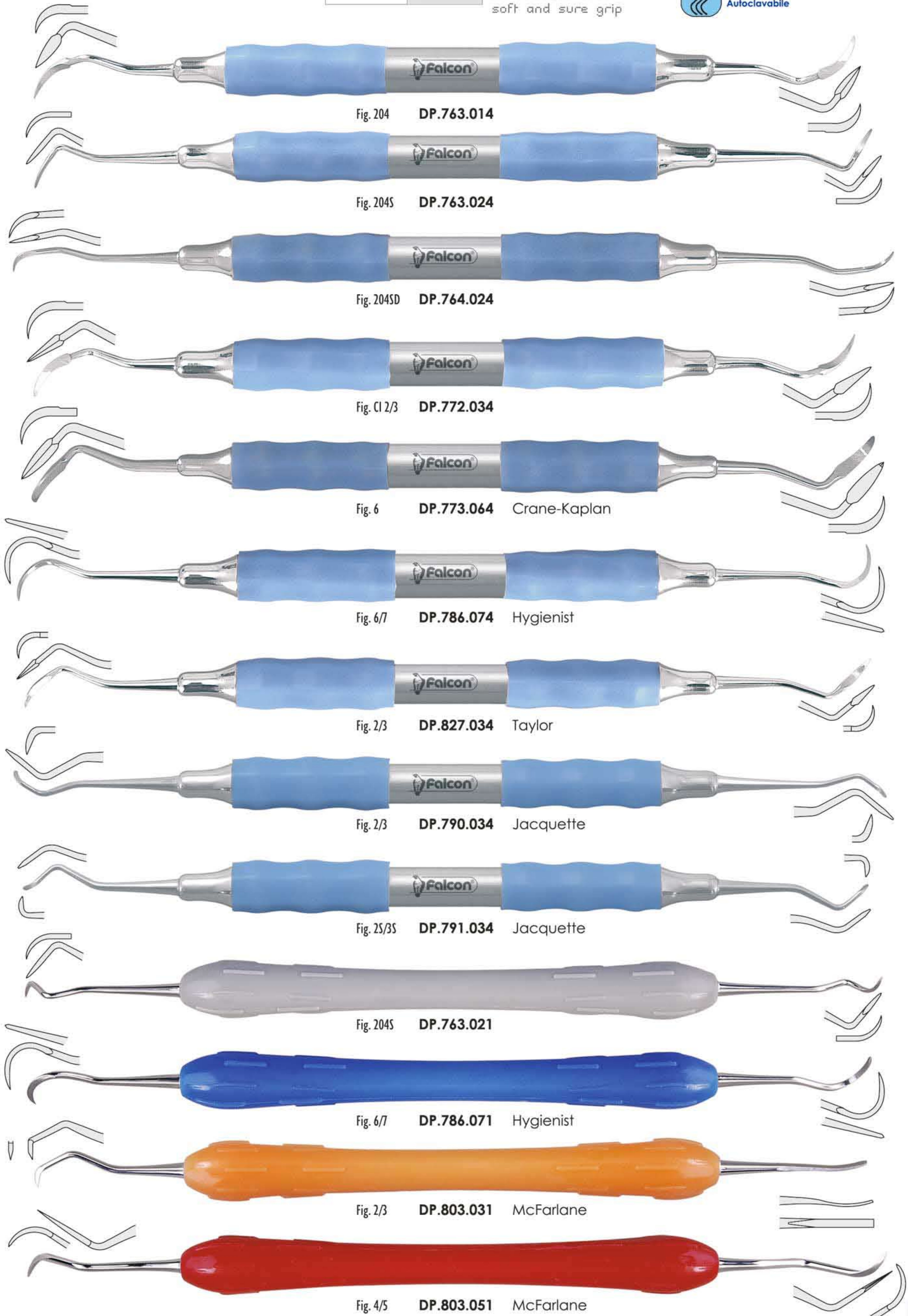

Classic-Round 6 mm solid handle
Manico pieno da 6mm

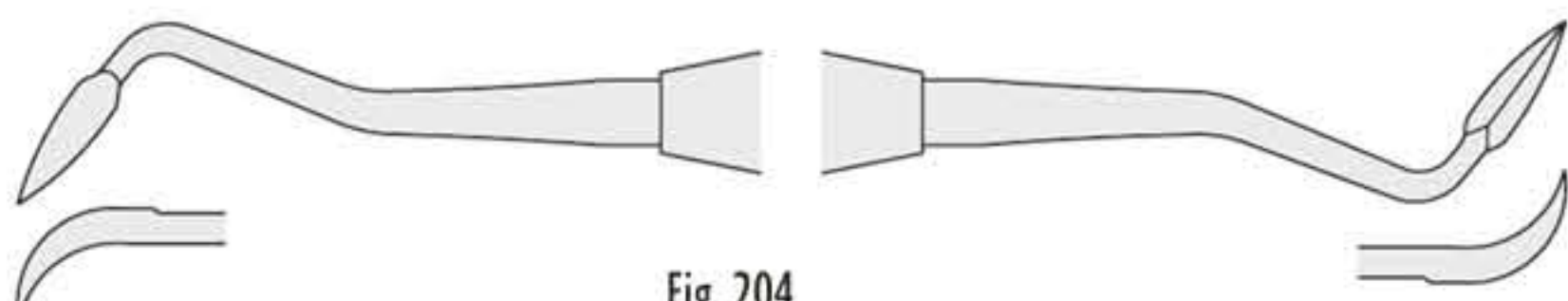

Fig. 204
DP.763.010

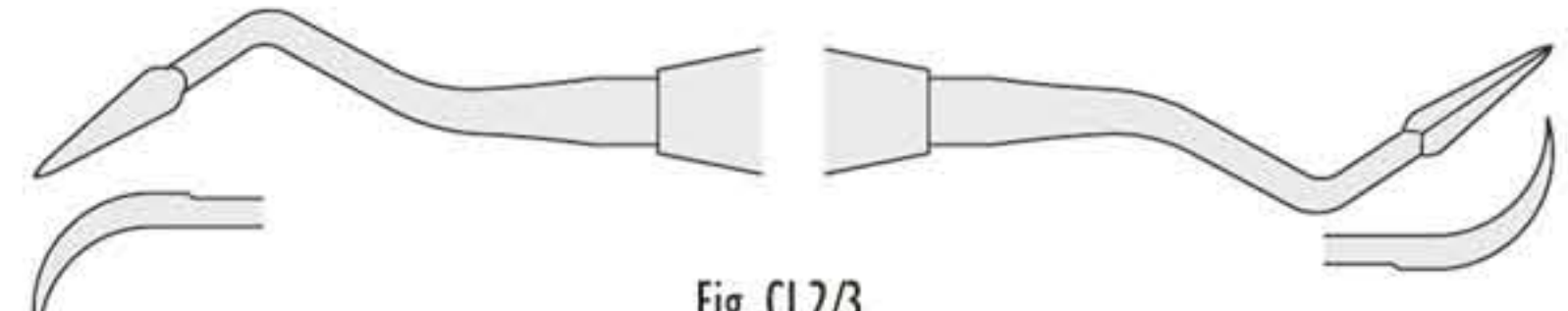

Fig. Cl 2/3
DP.772.030

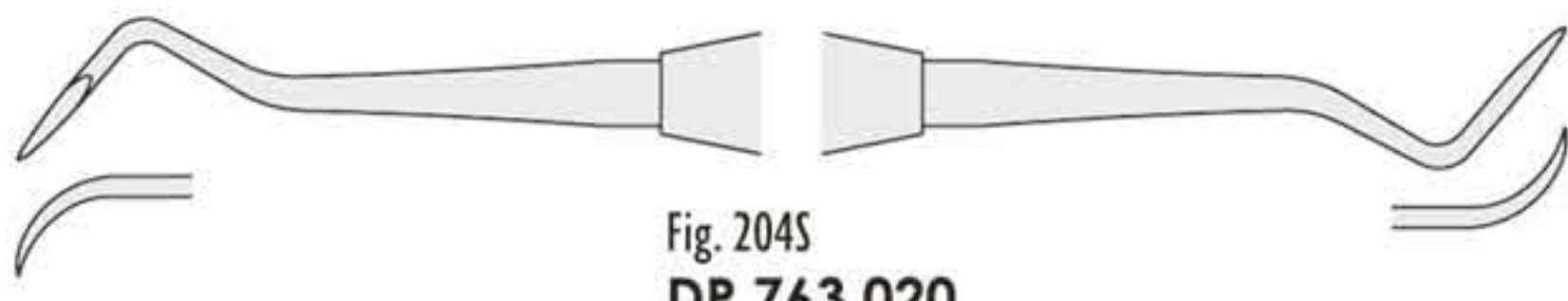

Fig. 204S
DP.763.020

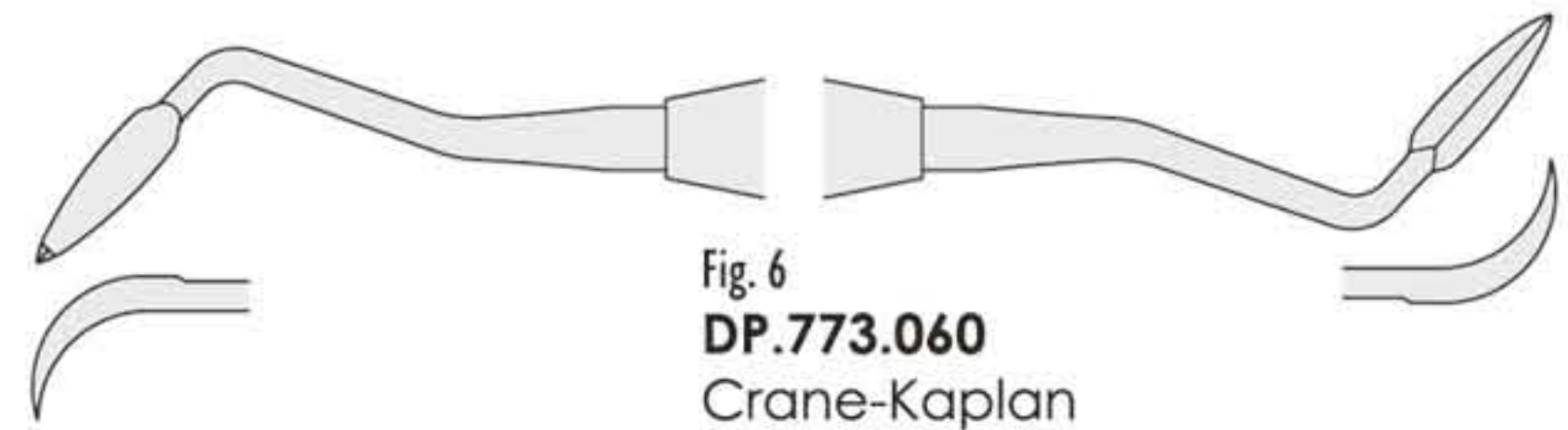

Fig. 6
DP.773.060
Crane-Kaplan

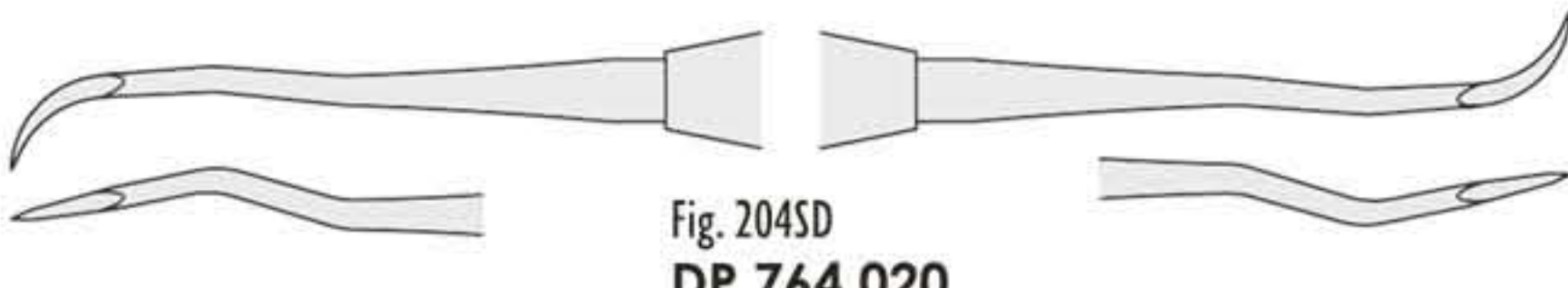

Fig. 204SD
DP.764.020

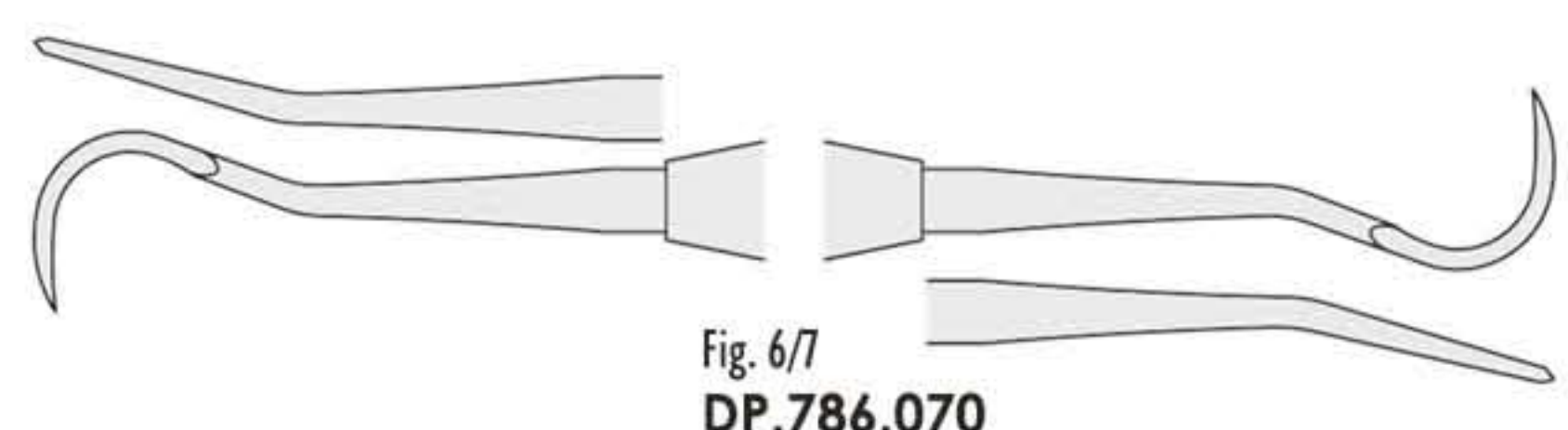

Fig. 6/7
DP.786.070
Hygienist

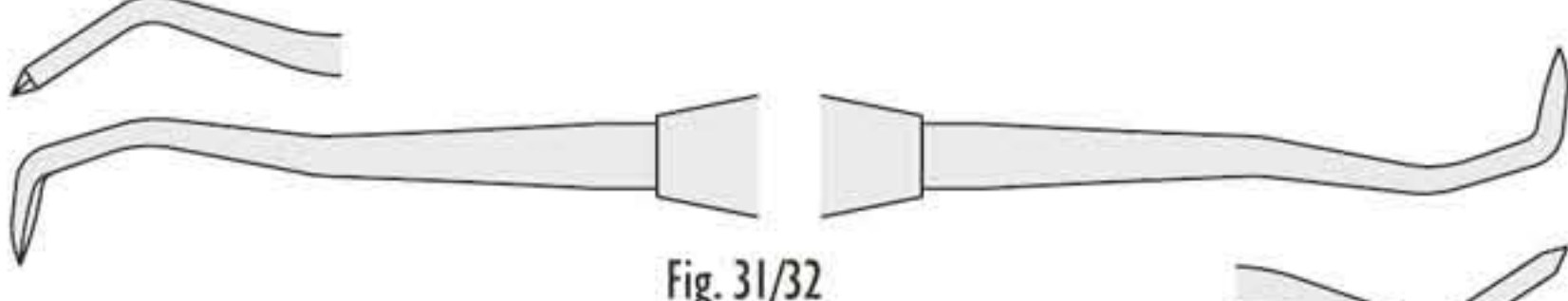

Fig. 31/32
DP.792.320
Jacquette

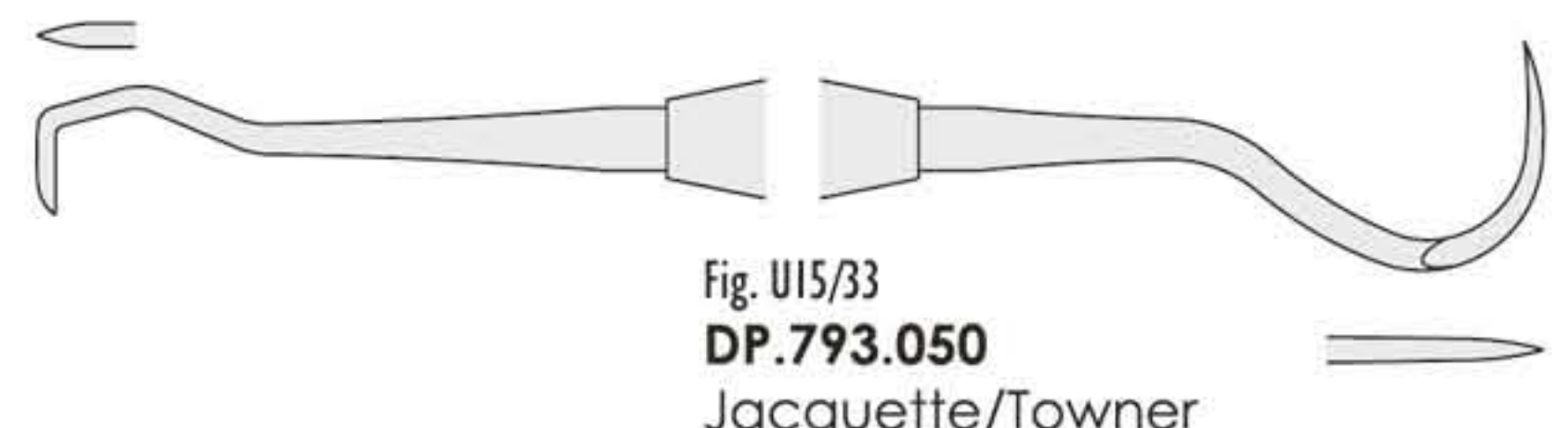

Fig. U15/33
DP.793.050
Jacquette/Towner

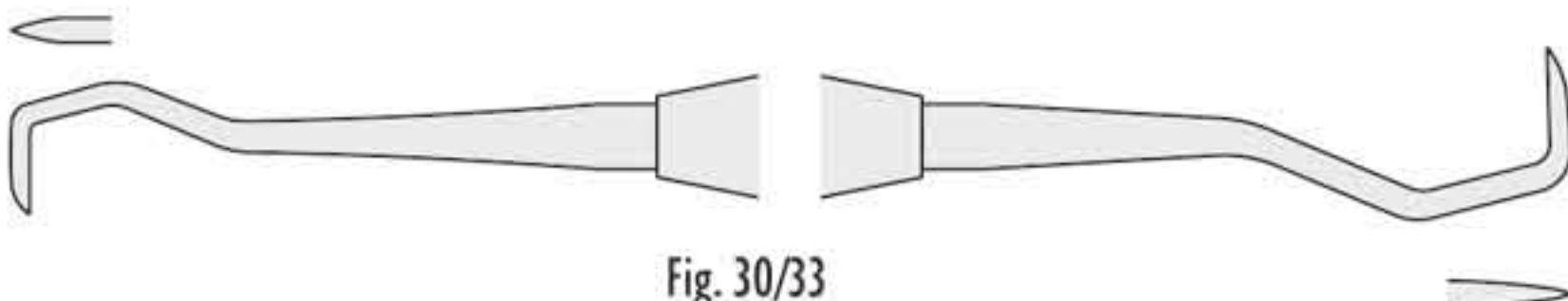

Fig. 30/33
DP.792.330
Jacquette

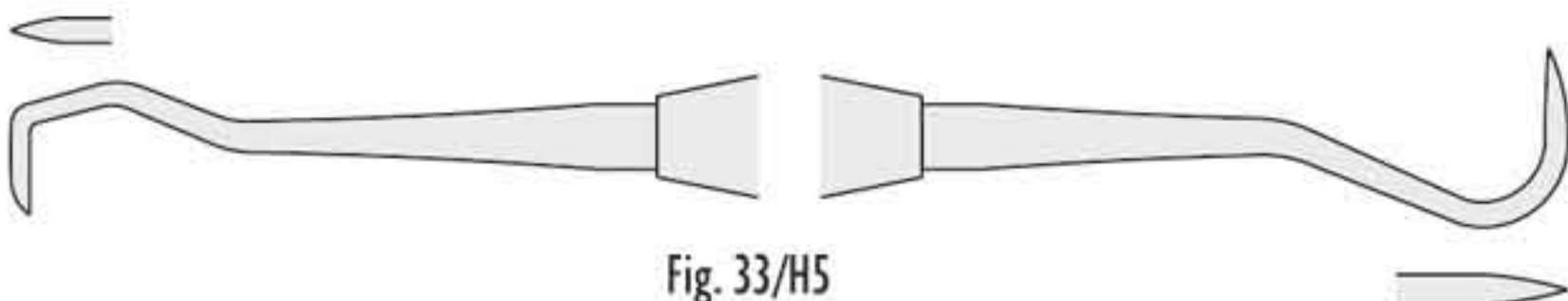

Fig. 33/H5
DP.793.020
Jacquette

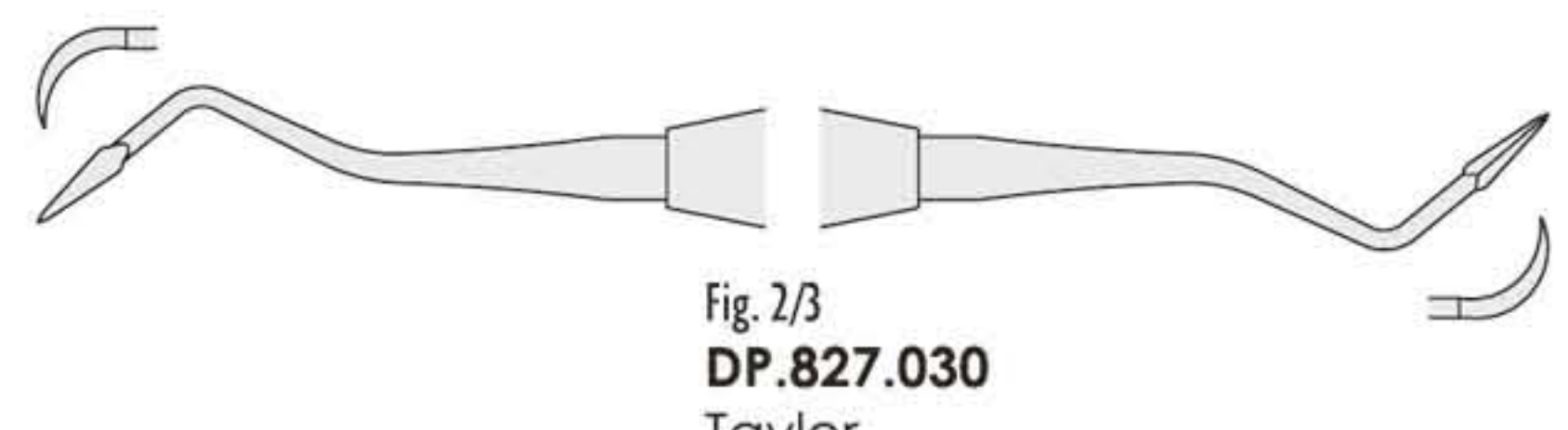

Fig. 2/3
DP.827.030
Taylor

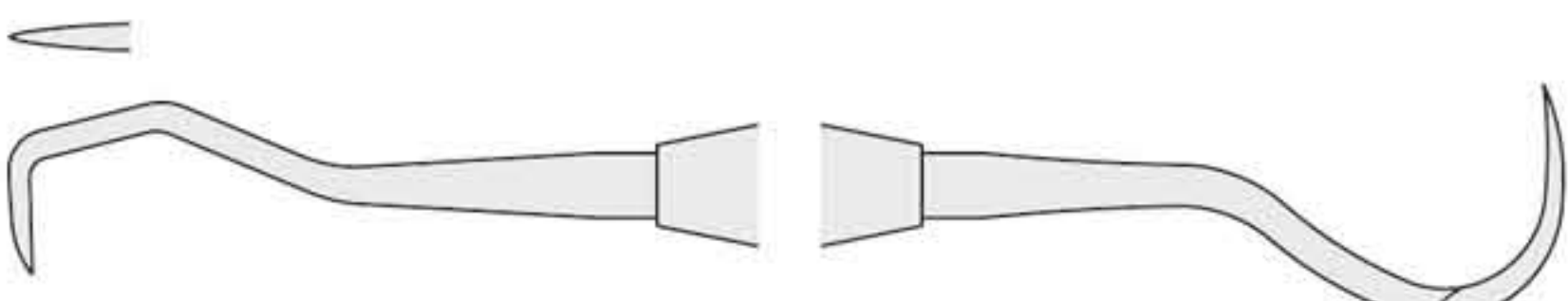

Fig. U15/30
DP.793.040
Jacquette/Towner

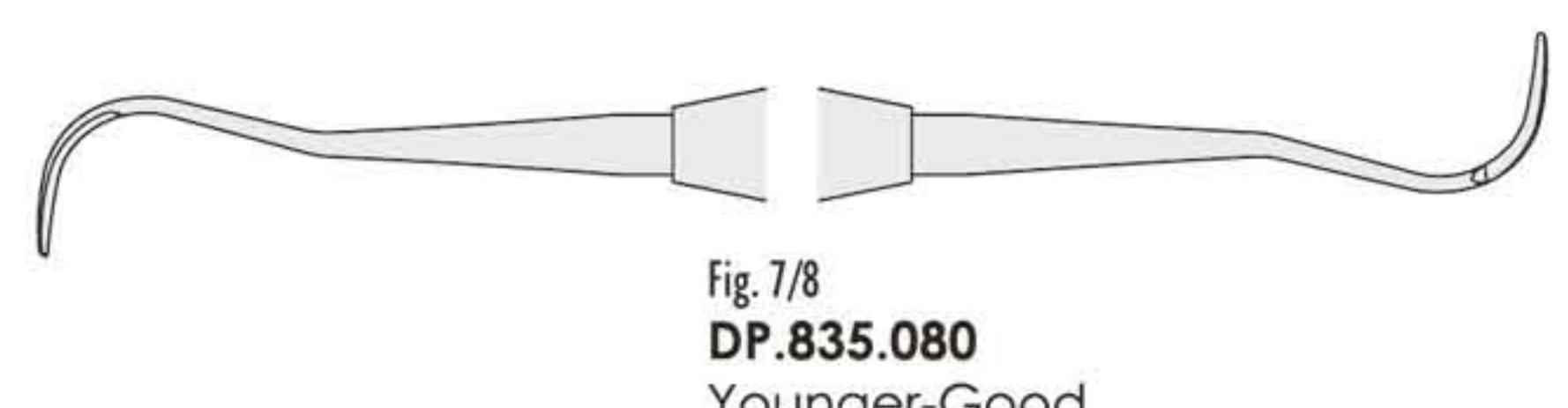

Fig. 7/8
DP.835.080
Younger-Good



BEST SELLER



CLASSIC-LITE 8 mm hollow handle
Manico vuoto da 8 mm

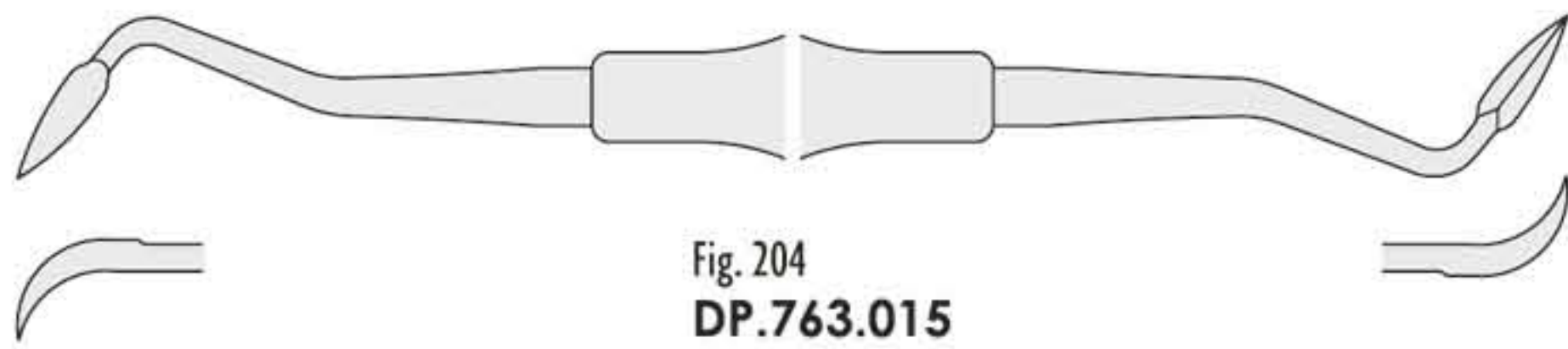

Fig. 204
DP.763.015

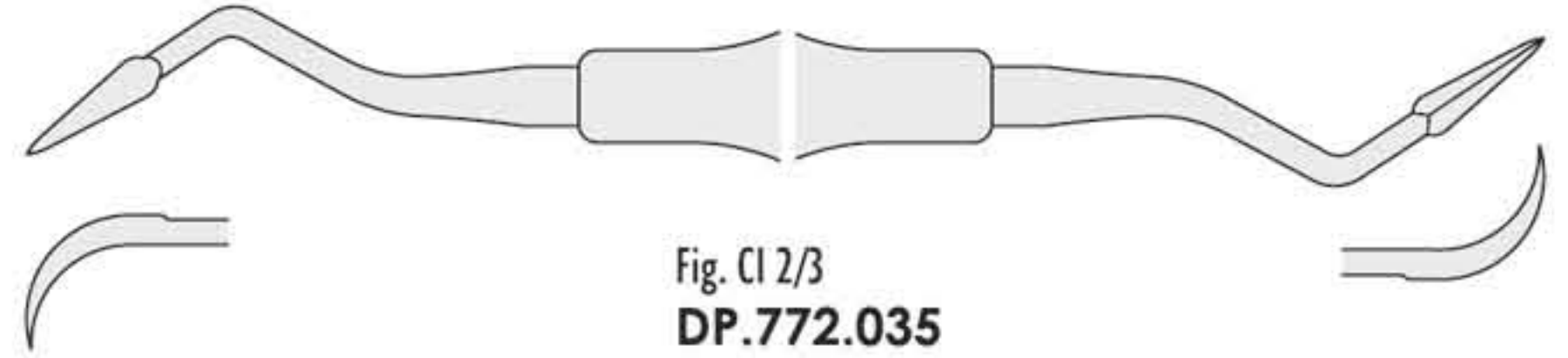

Fig. CI 2/3
DP.772.035

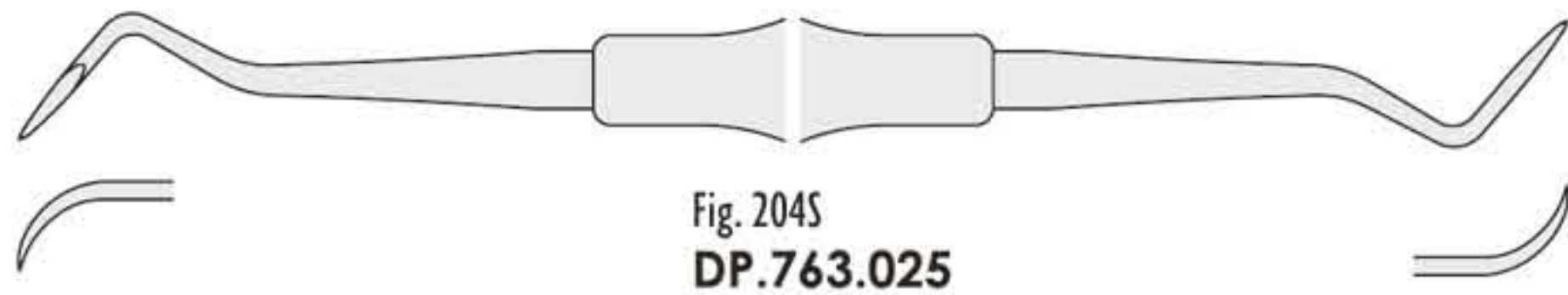

Fig. 204S
DP.763.025

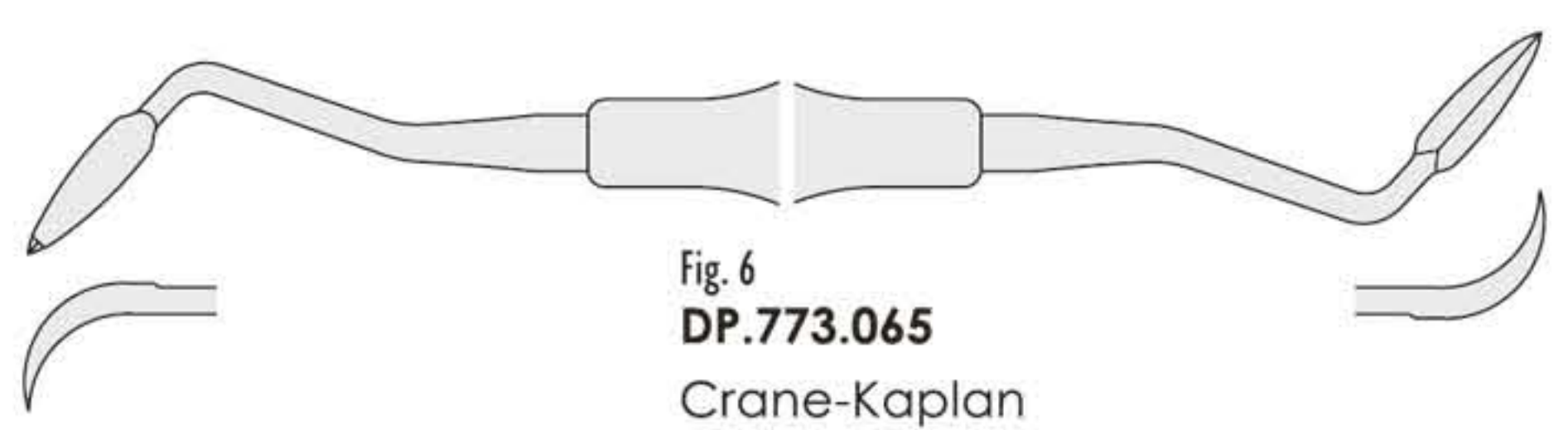

Fig. 6
DP.773.065
Crane-Kaplan

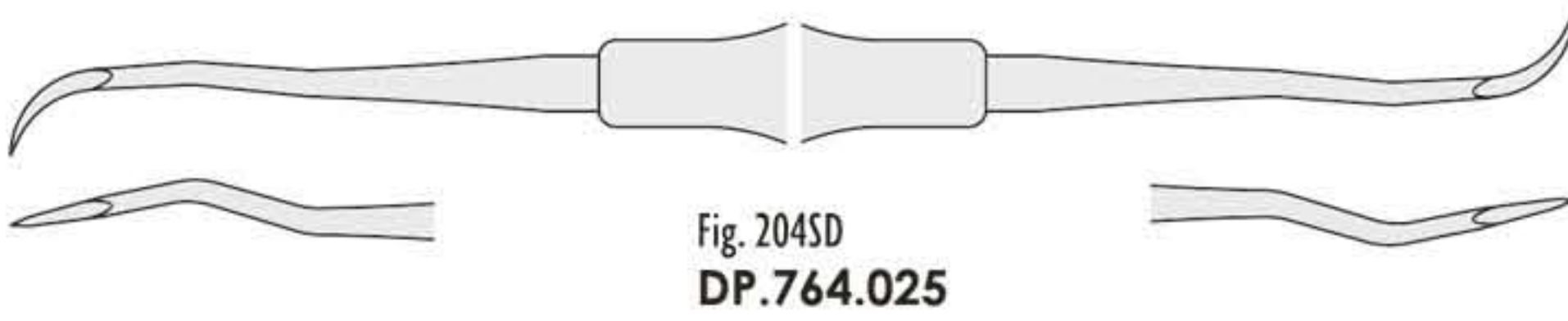

Fig. 204SD
DP.764.025

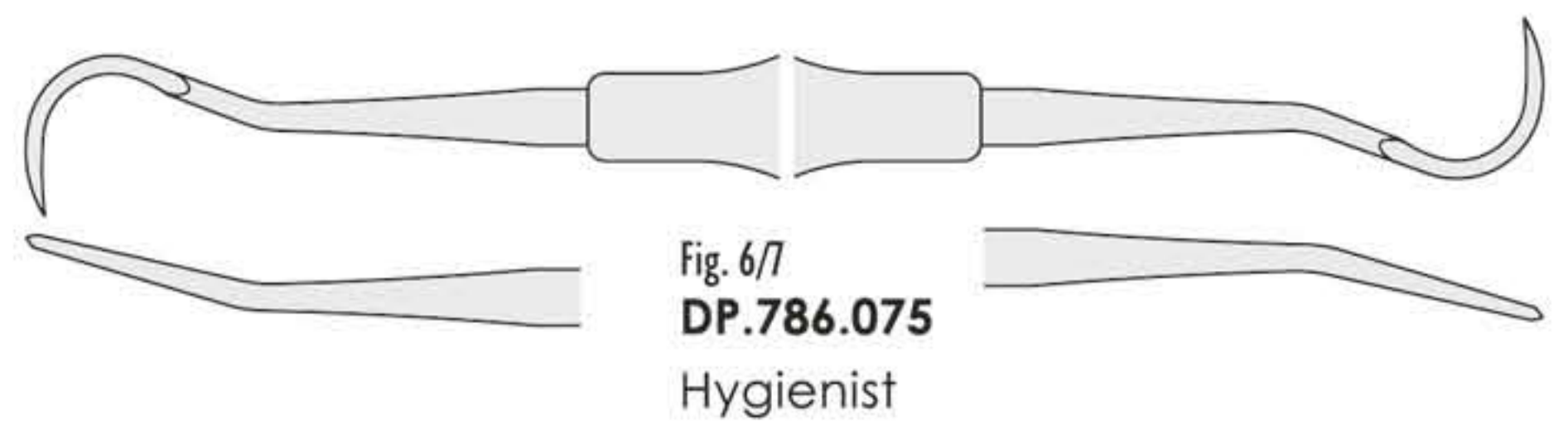

Fig. 6/7
DP.786.075
Hygienist

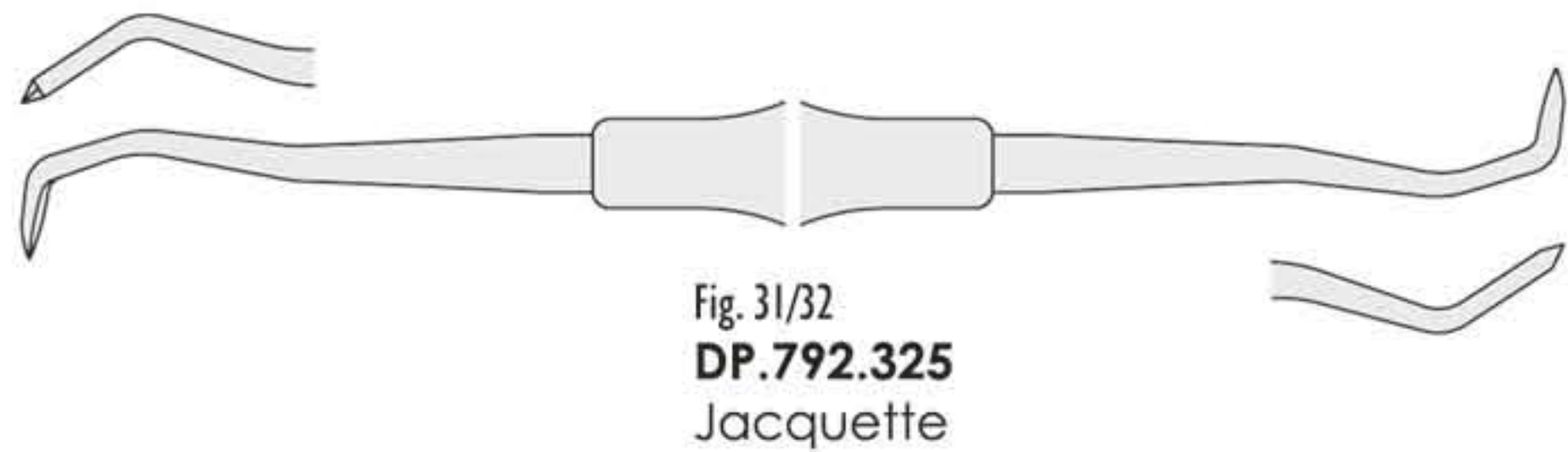

Fig. 31/32
DP.792.325
Jacquette



Fig. U15/33
DP.793.055
Jacquette/Towner

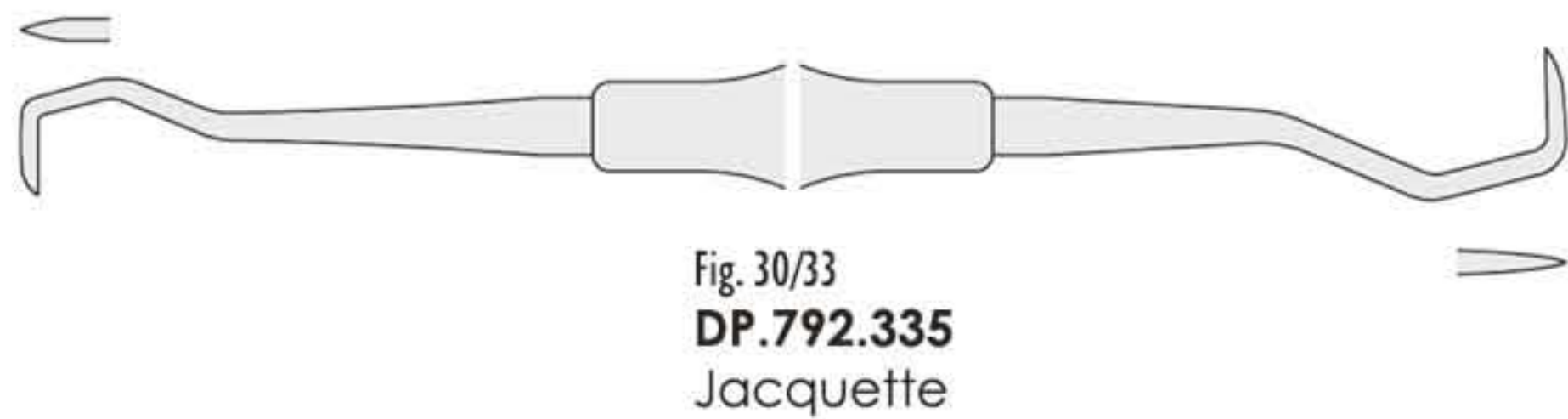

Fig. 30/33
DP.792.335
Jacquette

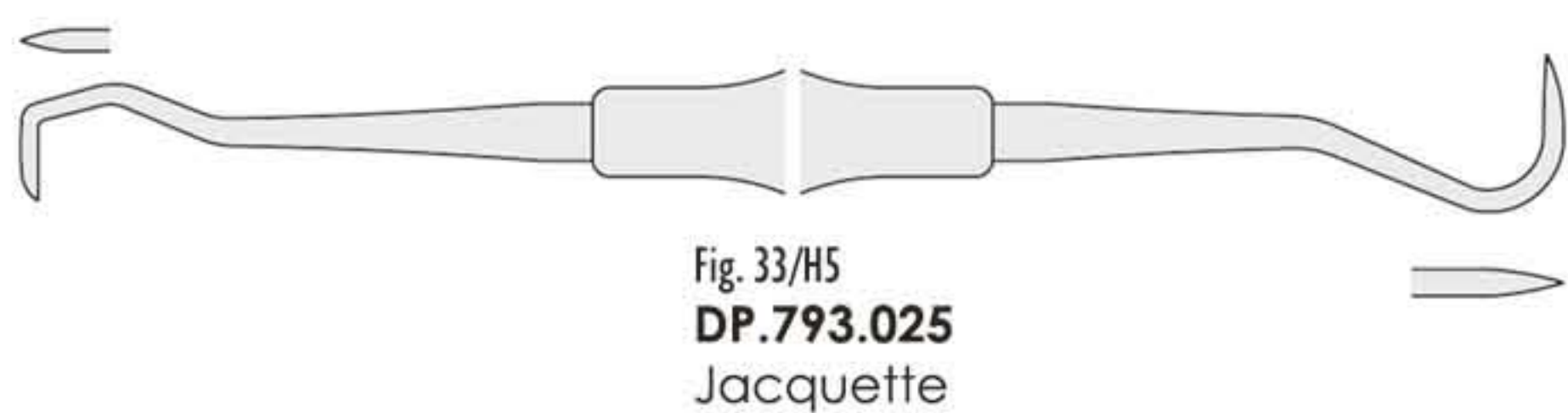

Fig. 33/H5
DP.793.025
Jacquette

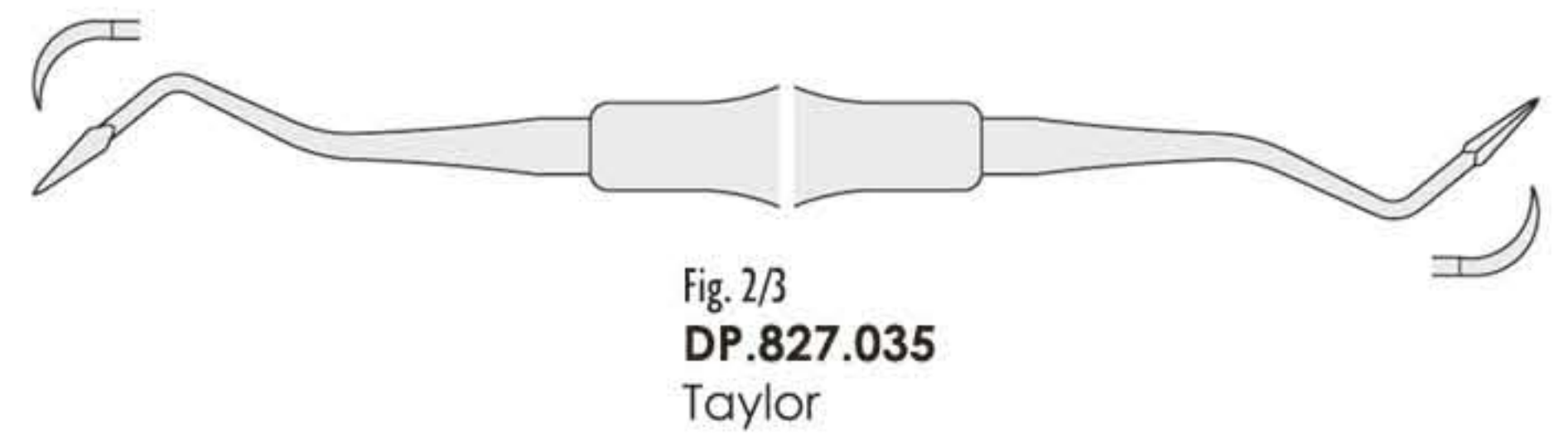

Fig. 2/3
DP.827.035
Taylor



Fig. U15/30
DP.793.045
Jacquette/Towner



Fig. 7/8
DP.835.085
Younger-Good

Scalers
Scalers (Levatartaro)

Classic-8
5.5 mm solid handle
Manico pieno da 5.5 mm



Darby Perry

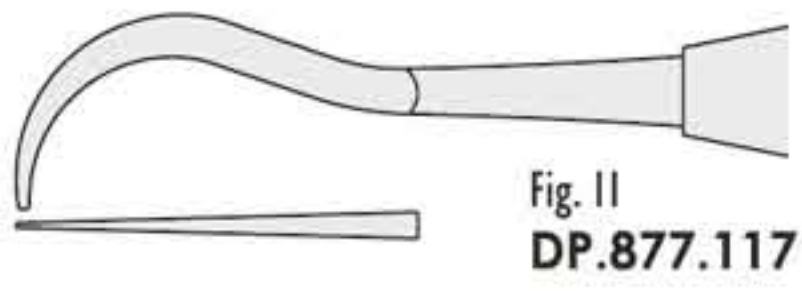

Standard

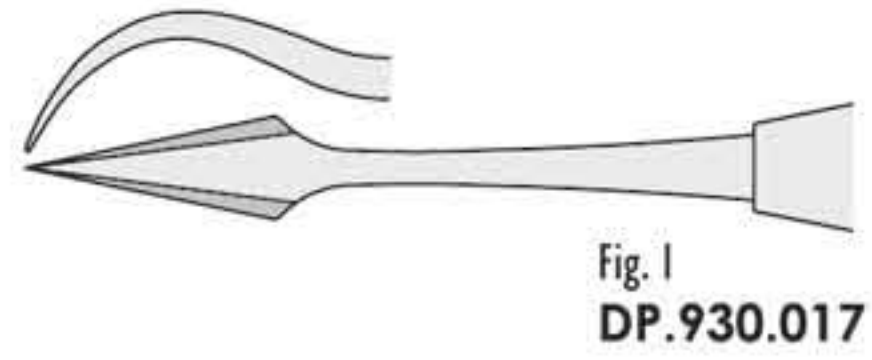

Standard

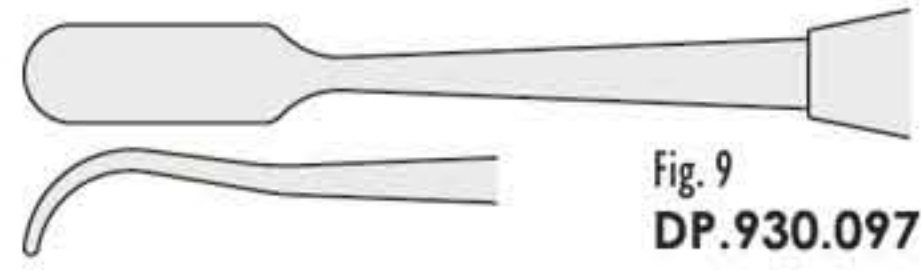

Falcon Polska

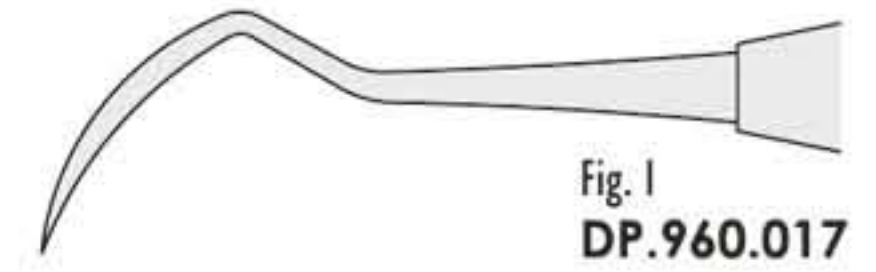

Hygienist

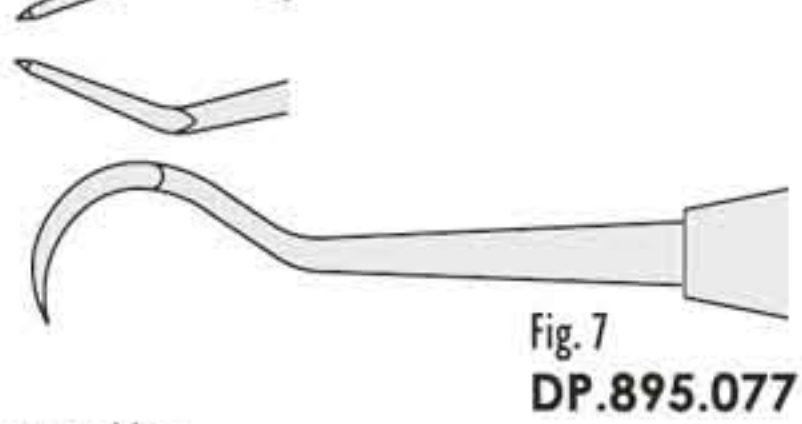
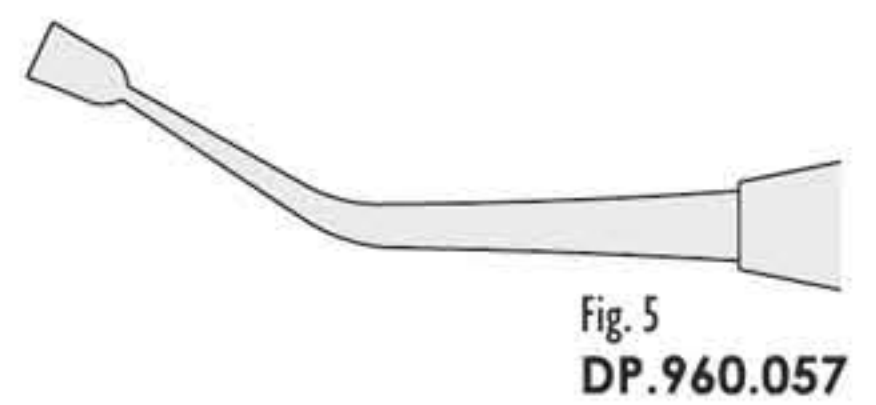
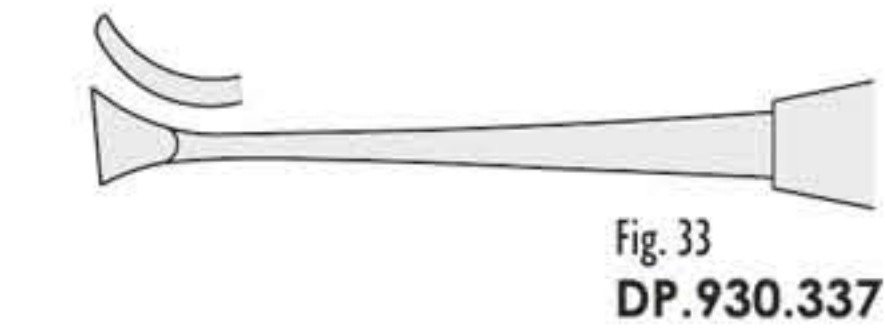
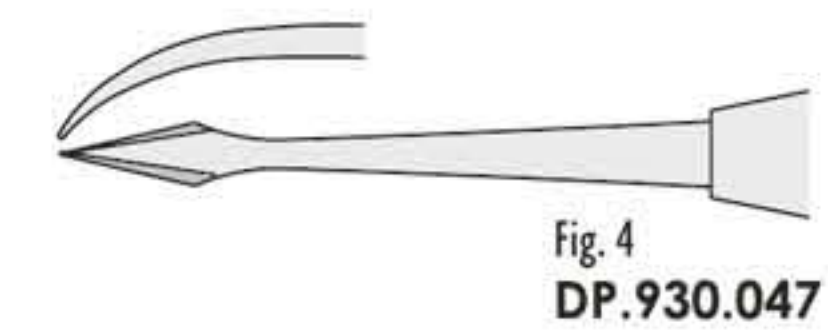
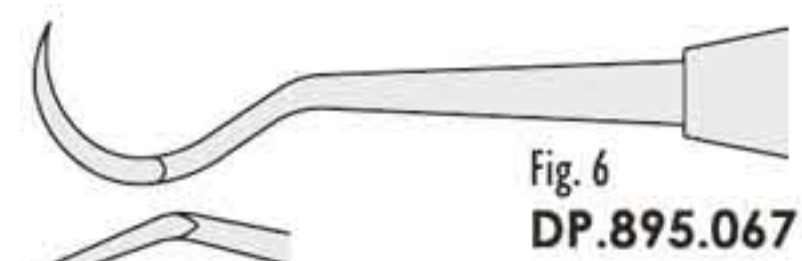
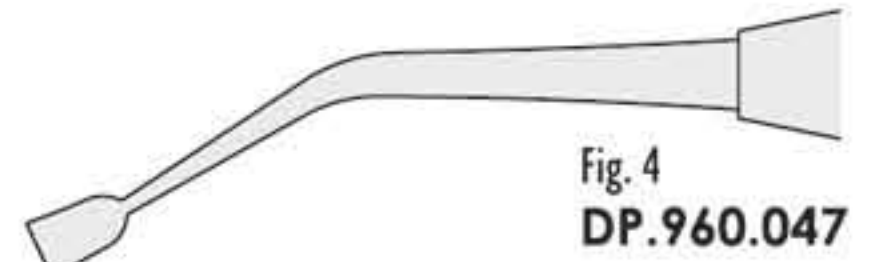
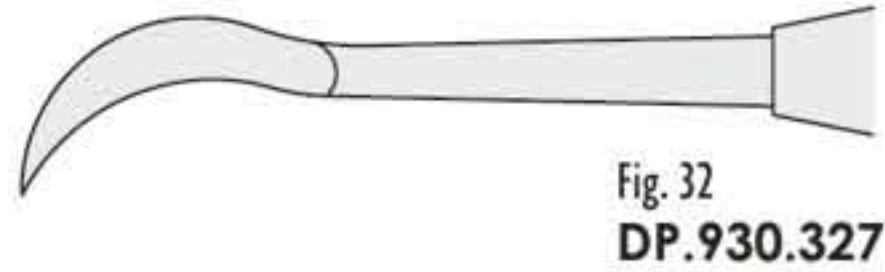
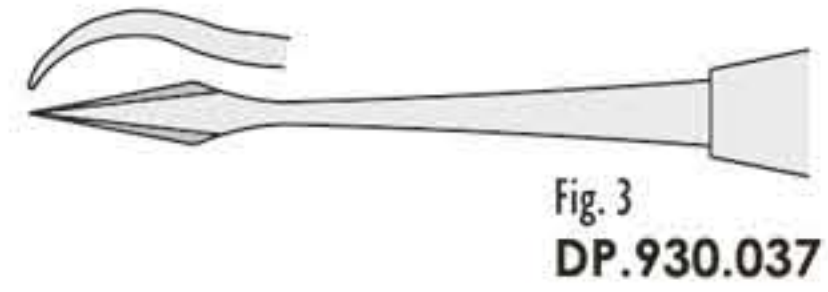
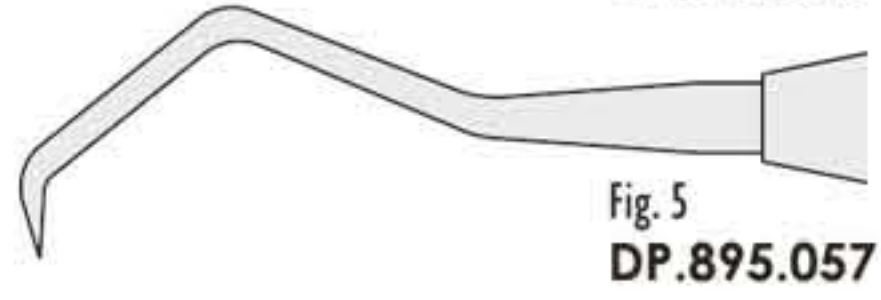
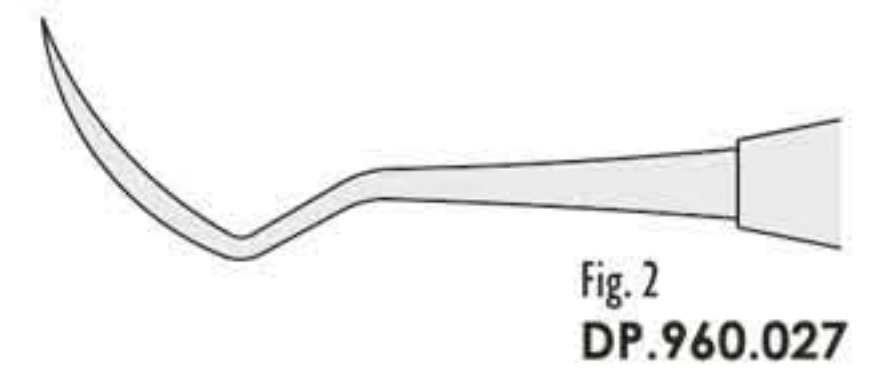
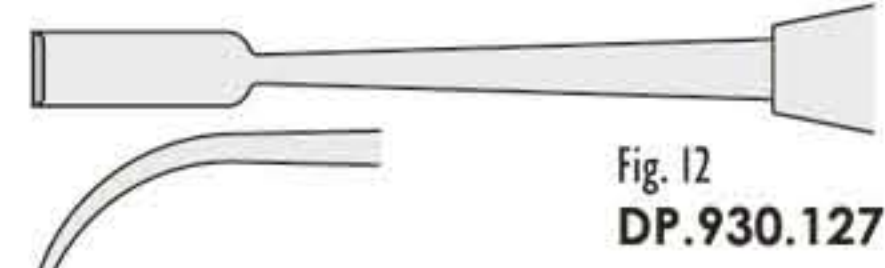
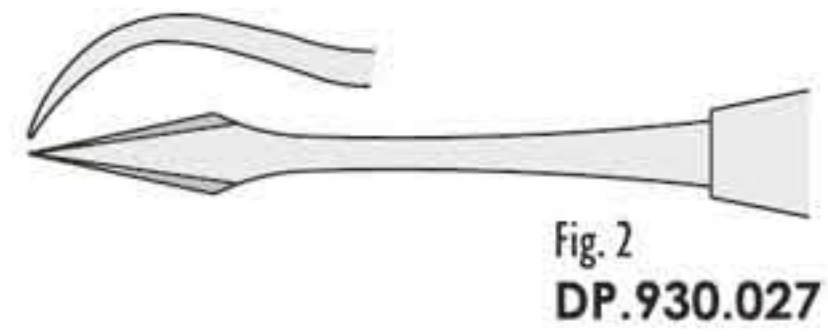
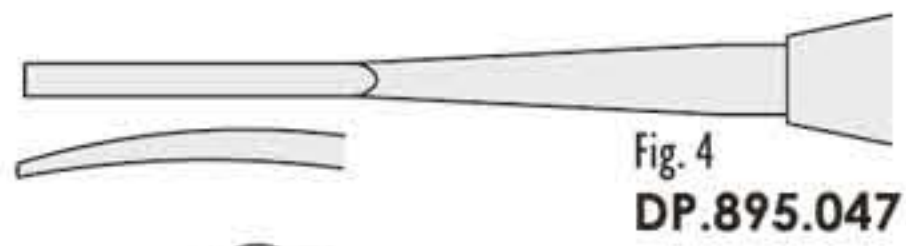

Jacquette

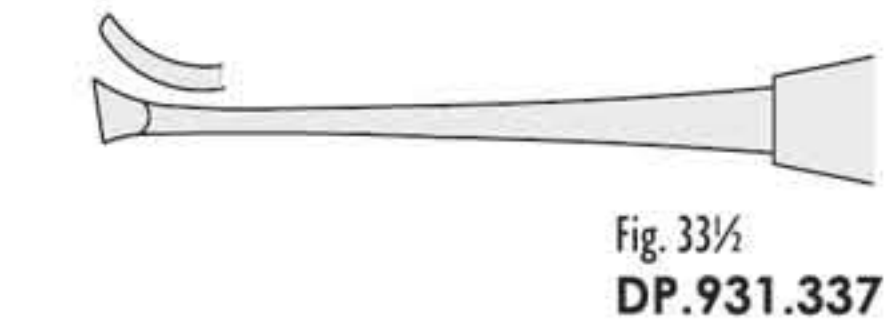
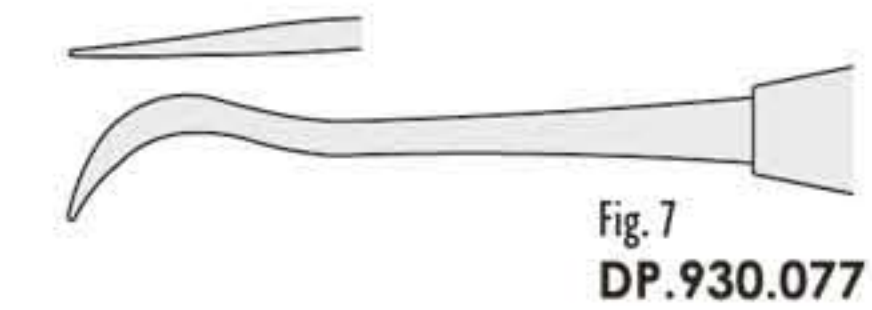
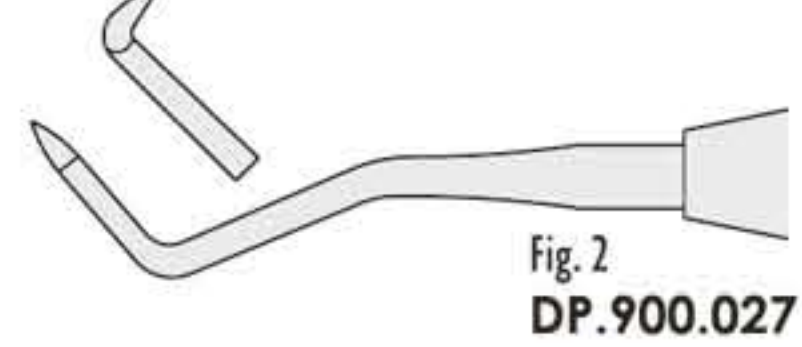
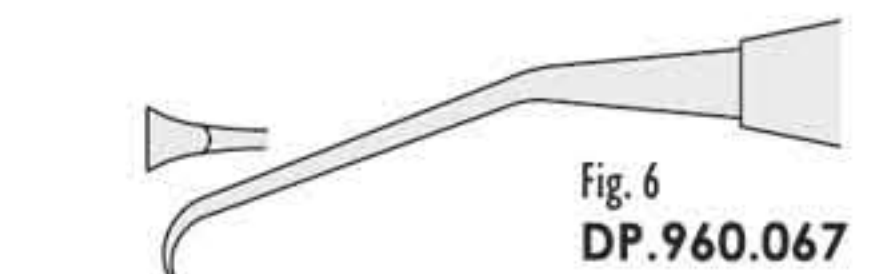
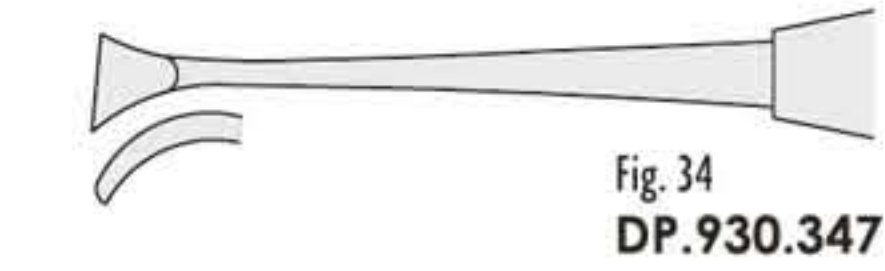
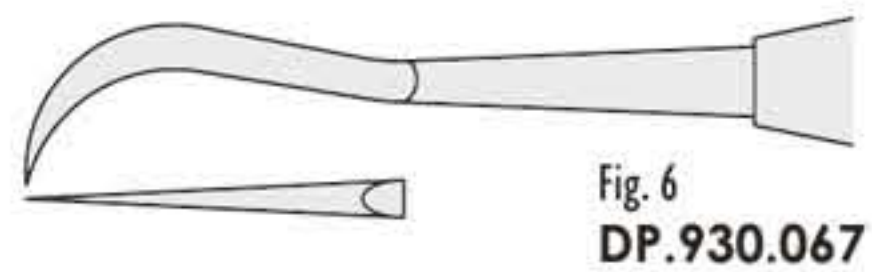
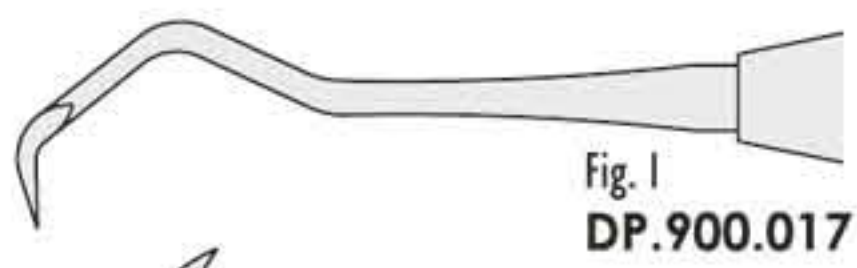

Towner

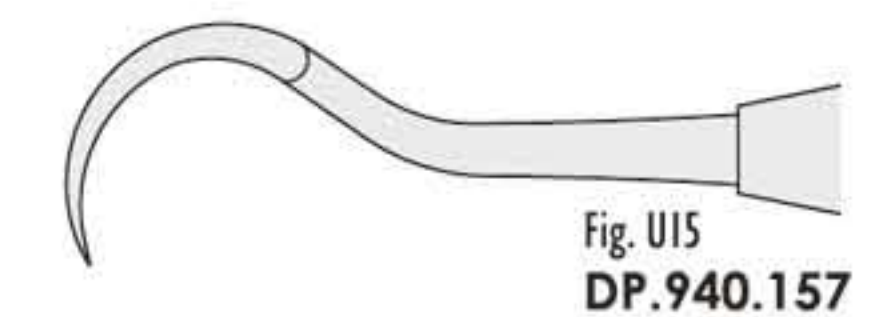
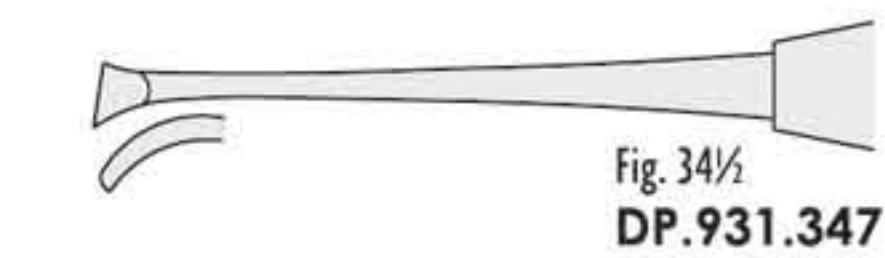
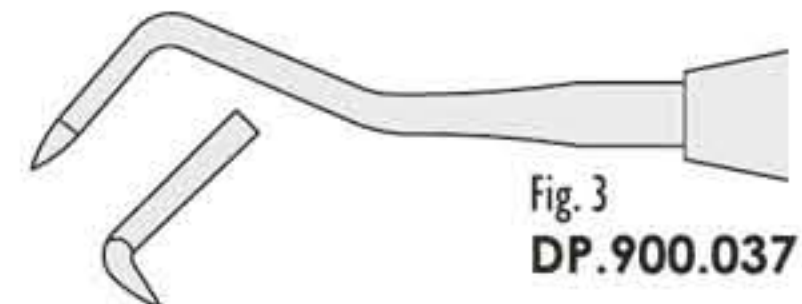

CLASSIC-LITE

8 mm hollow handle
Manico vuoto da 8 mm



Hygienist

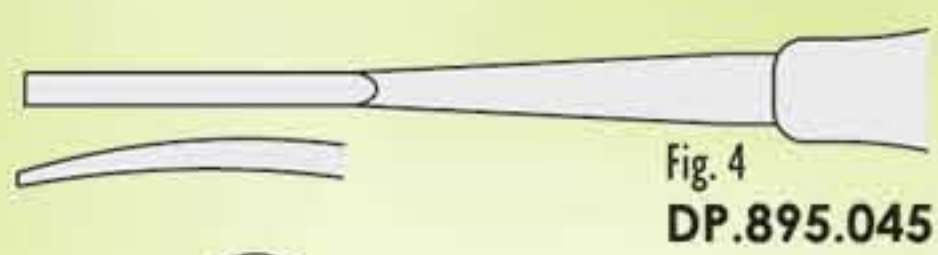

Jacquette

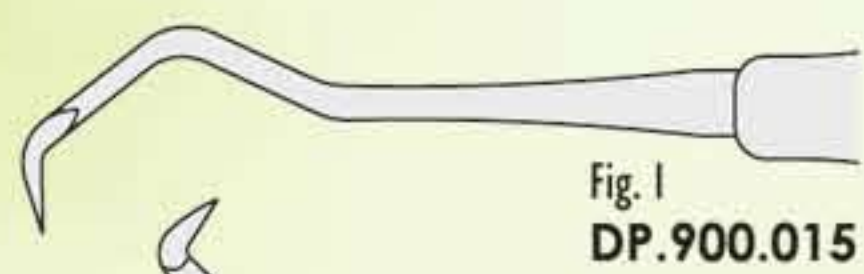

Standard

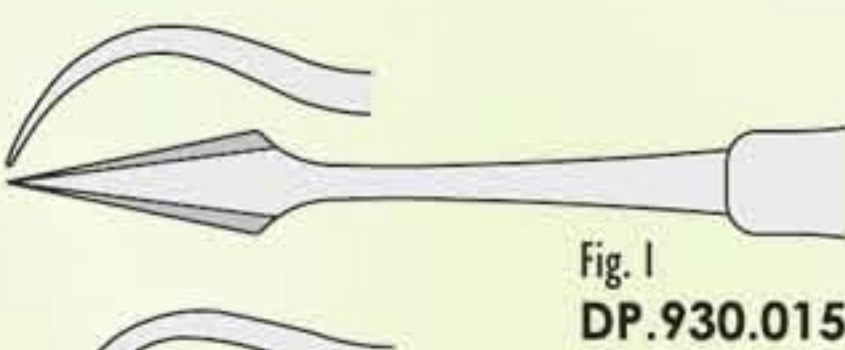

Standard

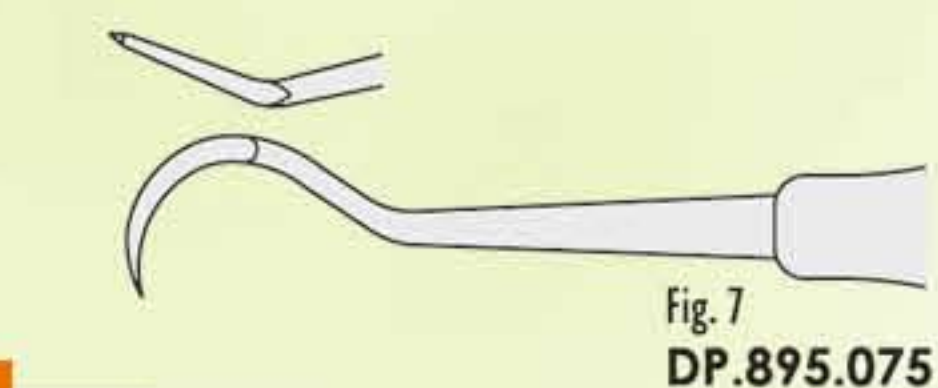
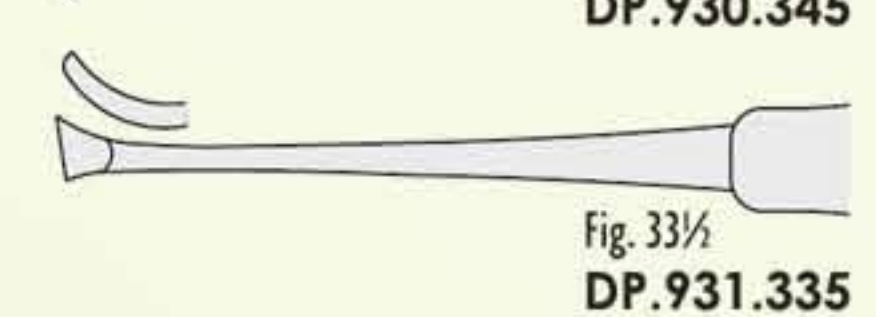
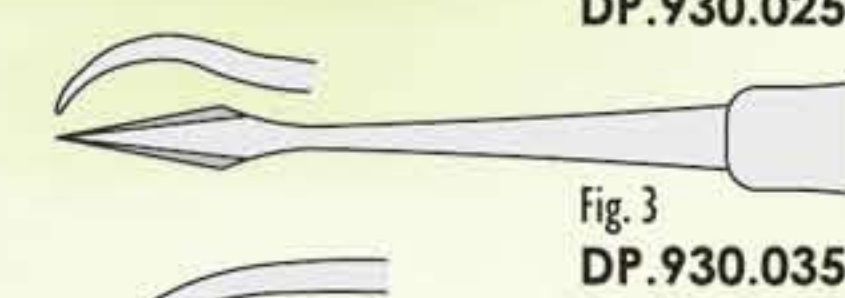
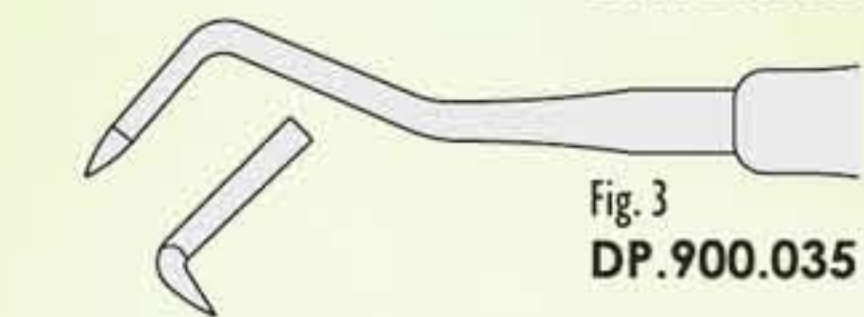
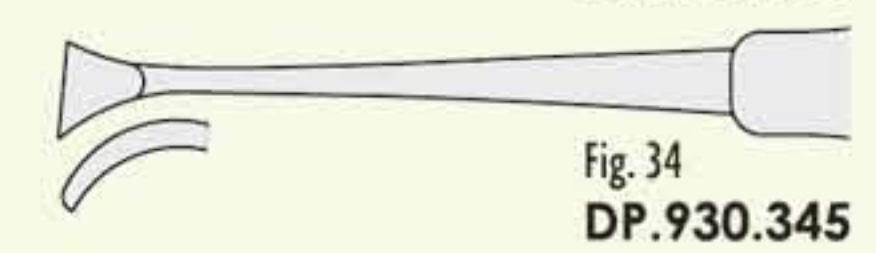
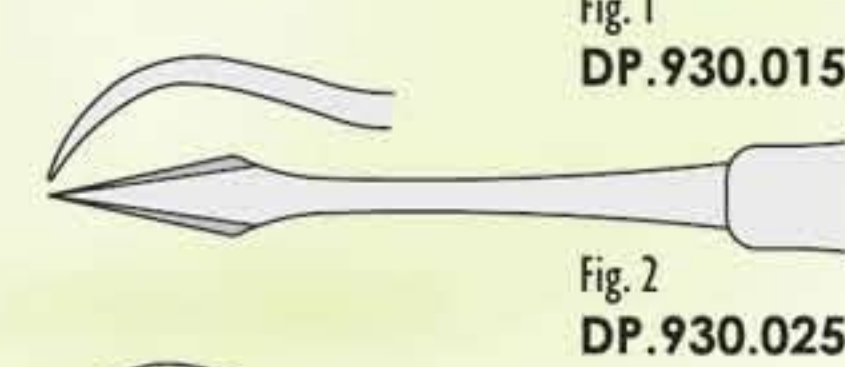
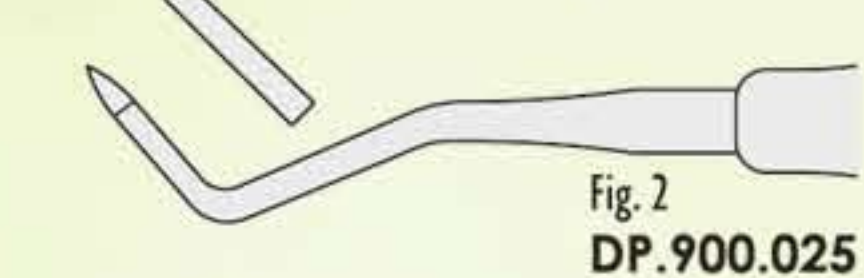
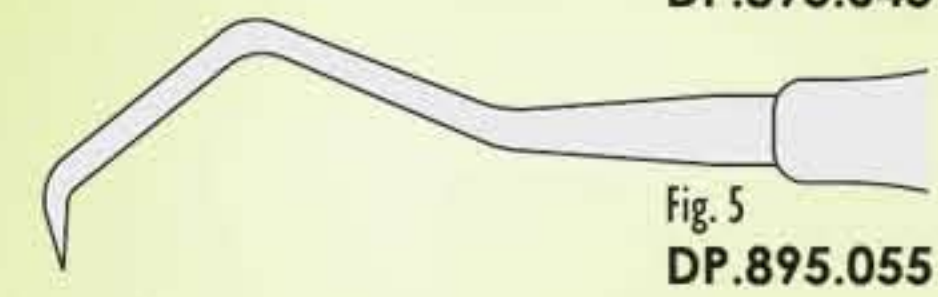
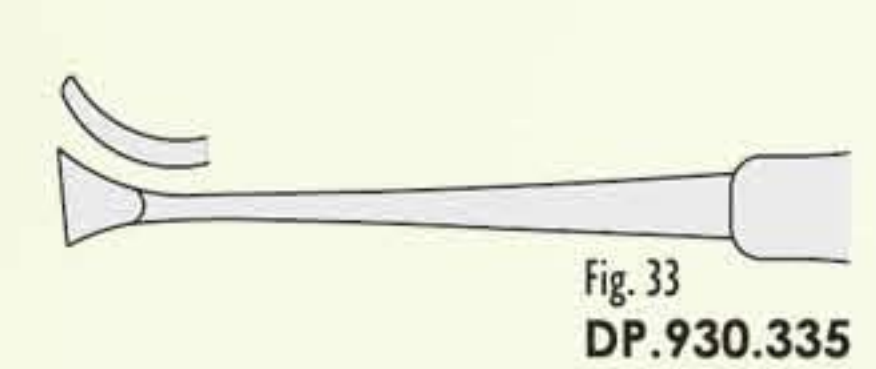

Towner

